

REC'D 1-9-98 SMM OK ✓



# Lee Surveying and Mapping Co., Inc.



Farm Surveys • Lot Surveys • Topography • Subdivisions • Construction Layout

117 NORTH MADRIVER STREET  
BELLEFONTAINE, OHIO 43311

(937) 593-7335  
FAX (937) 593-7444

## BURKHOLDER 11.934 ACRES

Lying in Virginia Military Survey 3326, Rushcreek Township, Logan County, Ohio.

Being out of the Carl Burkholder and Rosetta Burkholder original 47.597 acre tract as deeded and described in Official Record 298, Page 736 of the Logan County Records of Deeds and being more particularly described as follows:

Beginning at a 1/2 inch square bar found on the center-line of Ohio Route 47 at the intersection with the center-line of County Highway 5.

THENCE, with the center-line of Ohio Route 47 (60 feet wide), S 12°-58'-16" E, a distance of 361.66 feet to a railroad spike set.

THENCE, with the south line of the Roger D. Kennard 1.004 acre tract, (O.R. 311, Pg. 364), S 83°-52'-52" W, a distance of 301.27 feet to a 5/8 inch iron rod set at the TRUE POINT OF BEGINNING, passing a 5/8 inch iron rod set at 30.22 feet.

THENCE, S 5°-39'-26" E, a distance of 300.00 feet to a 5/8 inch iron rod set.

THENCE, S 84°-20'-34" W, a distance of 882.43 feet to a 5/8 inch iron rod set on the east line of the Steven R. Gregg 57.55 acre tract, (O.R. 105, Pg. 556).

THENCE, with the east line of the said 57.55 acre tract, N 4°-45'-42" W, a distance of 656.22 feet to a 5/8 inch iron rod set.

THENCE, and parallel to and 30.00 feet distance from the center-line of Township Road 273 (50 feet wide), N 88°-10'-52" E, a distance of 363.14 feet to a 5/8 inch iron rod set.

THENCE, and parallel to and 30.00 feet distance from the center-line of Township Road 273, N 83°-52'-52" E, a distance of 17.30 feet to a 5/8 inch iron rod set on the west line of the Roger D Kennard 1.027 acre tract, (O.R. 311, Pg. 370).

THENCE, with the lines of the said 1.027 acre tract, the following four (4) courses:

S 4°-45'-42" E, a distance of 211.50 feet to a 5/8 inch iron rod set.

N 83°-52'-52" E, a distance of 190.00 feet to a 5/8 inch iron rod set.

N 4°-45'-42" W, a distance of 185.90 feet to a 5/8 inch iron rod set.

With a curve to the left having a central angle of 91°-21'-26", a radius of 25.00 feet, an arc length of 39.86 feet, and a chord bearing N 50°-26'-25" W, a distance of 35.77 feet to a 5/8 inch iron rod set.

THENCE, parallel to and 30.00 feet distance from the center-line of Township Road 273, N 83°-52'-52" E, a distance of 328.17 feet to a 5/8 inch iron rod set at the northwest corner of the Carl Burkholder 0.918 acre tract, (O.R. 312, Pg. 671A).

THENCE, with the west line of the said 0.918 acre tract, and the west line of the aforementioned 1.004 acre tract, S 5°-39'-26" E, a distance of 335.94 feet to the point of beginning.

Containing 11.934 acres.

The basis for bearings is the center-line of Ohio Route 47 south of the intersection with Township Road 273, being S 12°-58'-16" E, and all other bearings are from angles and distances measured in a field survey by Lee Surveying and Mapping Co., Inc. on September 15, 1996 and December 29, 1997.

Description prepared by:

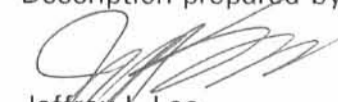
  
Jeffrey I. Lee  
Professional Surveyor 6359  
January 2, 1998

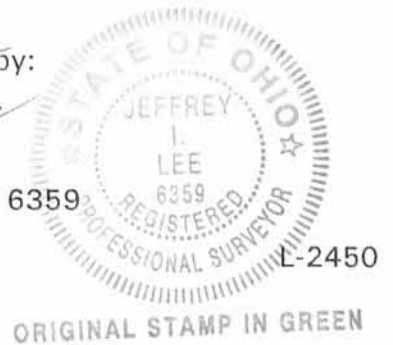

INDEXED ON MAP  
3389 9D-1

REC'D 1-9-98 SMY OK ✓



# Lee Surveying and Mapping Co., Inc.



Farm Surveys • Lot Surveys • Topography • Subdivisions • Construction Layout

117 NORTH MADRIVER STREET  
BELLEFONTAINE, OHIO 43311

(937) 593-7335  
FAX (937) 593-7444

## BURKHOLDER 15.750 ACRES

Lying in Virginia Military Survey 3326, Rushcreek Township and Jefferson Township, Logan County, Ohio.

Being out of the Carl Burkholder and Rosetta Burkholder original 47.597 acre tract as deeded and described in Official Record 298, Page 736 of the Logan County Records of Deeds and being more particularly described as follows:

Beginning at a 1/2 inch square iron bar found on the center-line of Ohio Route 47 at the intersection with the center-line of County Highway 5.

THENCE, with the center-line of Ohio Route 47 (60 feet wide), the following three (3) courses:

S 12°-58'-16" E, a distance of 662.04 feet to a MAG nail set.

With a curve to the right having a central angle of 12°-53'-50", a radius of 1143.27 feet, an arc length of 257.35 feet, and a chord bearing S 6°-31'-21" E, a distance of 256.80 feet to a MAG nail set.

S 0°-04'-26" E, a distance of 214.23 feet to a MAG nail set at the TRUE POINT OF BEGINNING.

THENCE, with the center-line of Ohio Route 47, the following three (3) courses:

S 0°-04'-26" E, a distance of 69.48 feet to a MAG nail set.

With a curve to the right having a central angle of 12°-50'-51", a radius of 1434.99 feet, an arc length of 321.77 feet, and a chord bearing S 6°-20'-59" W, a distance of 321.10 feet to a MAG nail set.

S 12°-46'-25" W, a distance of 40.47 feet to a railroad spike found on the northeast corner of the Richard H. Smiley 5.013 acre tract, (O.R. 234, Pg. 710).

THENCE, with the north line of the said 5.013 acre tract, S 85°-29'-05" W, a distance of 574.27 feet to a 5/8 inch iron rod found, passing a 5/8 inch iron rod found at 31.42 feet.

THENCE, with the west line of the said 5.013 acre tract, S 4°-29'-01" E, a distance of 429.51 feet to a railroad spike found on the center-line of Ohio Route 47, passing a 5/8 inch iron rod found at 399.51 feet.

THENCE, with the center-line of Ohio Route 47, S 85°-30'-00" W, a distance of 406.00 feet to a railroad spike set on the southeast corner of the Roger D. Kennard 1.022 acre tract, (O.R. 311, Pg. 367).

THENCE, with the east line of the said 1.022 acre tract, N 4°-45'-42" W, a distance of 266.85 feet to a 5/8 inch iron rod set, passing a 5/8 inch iron rod set at 30.00 feet.

THENCE, with the north line of the said 1.022 acre tract, S 85°-30'-00" W, a distance of 150.00 feet to a 5/8 inch iron rod set on the east line of the Steven R. Gregg 57.55 acre tract, (O.R. 105, Pg. 556).

THENCE, with the east line of the said 57.55 acre tract, N 4°-45'-42" W, a distance of 540.93 feet to a 5/8 inch iron rod set.

THENCE, N 84°-47'-00" E, a distance of 1212.13 feet to the point of beginning, passing a 5/8 inch iron rod set at 1182.07 feet.

Containing 15.750 acres, of which, 14.319 acre is in Rushcreek Township, 1.431 acres is in Jefferson Township, and 0.578 acre is within the highway right-of-way.

The basis for bearings is the center-line of Ohio Route 47 south of the intersection with Township Road 273, being S 12°-58'-16" E, and all other bearings are from angles and distances measured in a field survey by Lee Surveying and Mapping Co., Inc. on September 15, 1996 and December 29, 1997.

Description prepared by:

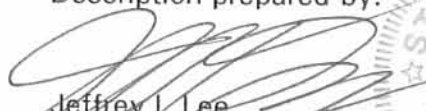
  
Jeffrey J. Lee  
Professional Surveyor 6359  
January 2, 1998

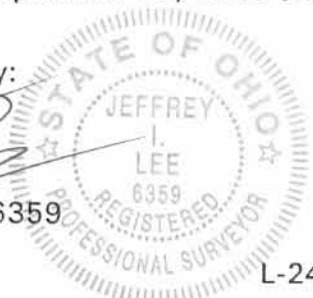

L-2450

INDEXED ON MAP  
3389 9D-2

ORIGINAL STAMP IN GREEN

REC'D 1-9-98 SML/OLV



# Lee Surveying and Mapping Co., Inc.



Farm Surveys • Lot Surveys • Topography • Subdivisions • Construction Layout

117 NORTH MADRIVER STREET  
BELLEFONTAINE, OHIO 43311

(937) 593-7335  
FAX (937) 593-7444

## BURKHOLDER 15.193 ACRES

Lying in Virginia Military Survey 3326, Rushcreek Township, Logan County, Ohio.

Being out of the Carl Burkholder and Rosetta Burkholder original 47.597 acre tract as deeded and described in Official Record 298, Page 736 of the Logan County Records of Deeds and being more particularly described as follows:

Beginning at a 1/2 inch square iron bar found on the center-line of Ohio Route 47 at the intersection with the center-line of County Highway 5.

THENCE, with the center-line of Ohio Route 47 (60 feet wide), S 12°-58'-16" E, a distance of 361.66 feet to a railroad spike set at the TRUE POINT OF BEGINNING.

THENCE, with the center-line of Ohio Route 47, the following three (3) courses:

S 12°-58'-16" E, a distance of 300.38 feet to a MAG nail set.

With a curve to the right having a central angle of 12°-53'-50", a radius of 1143.27 feet, an arc length of 257.35 feet, and a chord bearing S 6°-31'-21" E, a distance of 256.80 feet to a MAG nail set.

S 0°-04'-26" E, a distance of 214.23 feet to a MAG nail set.

THENCE, S 84°-47"-00" W, a distance of 1212.13 feet to a 5/8 inch iron rod set on the east line of the Steven R. Gregg 57.55 acre tract, (O.R. 105, Pg. 556), passing a 5/8 inch iron rod set at 30.06 feet.

THENCE, with the east line of the said 57.55 acre tract, N 4°-45'-42" W, a distance of 456.24 feet to a 5/8 inch iron rod set.

THENCE, N 84°-20'-34" E, a distance of 882.43 feet to a 5/8 inch iron rod set.

THENCE, N 5°-39'-26" W, a distance of 300.00 feet to a 5/8 inch iron rod set at the southwest corner of the Roger D. Kennard 1.004 acre tract, (O.R. 311, Pg. 364).

THENCE, with the south line of the said 1.004 acre tract, N 83°-52'-52" E, a distance of 301.27 feet to the point of beginning, passing a 5/8 inch iron rod set at 271.05 feet.

Containing 15.193 acres, of which, 0.531 acre is within the highway right-of-way.

The basis for bearings is the center-line of Ohio Route 47 south of the intersection with Township Road 273, being S 12°-58'-16" E, and all other bearings are from angles and distances measured in a field survey by Lee Surveying and Mapping Co., Inc. on September 15, 1996 and December 29, 1997.

Description prepared by:

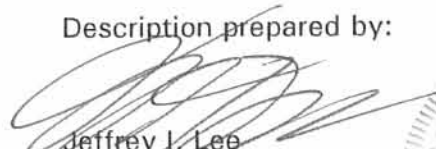
  
Jeffrey J. Lee  
Professional Surveyor 6359  
January 2, 1998



ORIGINAL STAMP IN GREEN

33099D3

IMOGENE LENMART  
82.06 ACRES  
O.R. 27, PG. 804

TOWNSHIP ROAD 273 (50')

V.M.S. 3323  
V.M.S. 3326

CURVE	DELTA ANGLE	RADIUS	ARC	TANGENT	CHORD	CHORD BEARING
C 1	91°21'26"	25.00'	39.86'	25.60'	35.77'	N 50°26'25"W
C 2	12°53'50"	1143.27'	257.35'	129.22'	256.80'	S 06°31'21"E
C 3	12°50'51"	1434.99'	321.77'	161.56'	321.10'	S 06°20'59"W

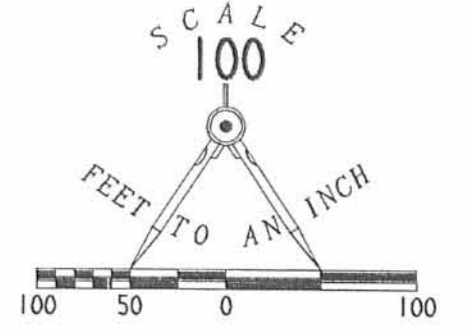

REFERENCES  
LOGAN COUNTY ENGINEER'S FILES:  
R-3447, R-3389, R-1703, R-2714, R-1377  
R-5941, R-5534

- LEGEND
- 5/8" IRON ROD SET
  - 5/8" IRON ROD FOUND
  - ⊕ RAILROAD SPIKE SET
  - ⊙ RAILROAD SPIKE FOUND
  - ⊗ CONCRETE RIGHT OF WAY MONUMENT FOUND
  - 1/2" SQUARE IRON BAR FOUND
  - ⊙ MAG NAIL SET



SURVEY OF THREE TRACT OUT OF THE  
CARL BURKHOLDER AND ROSETTA BURKHOLDER  
ORIGINAL 47.597 ACRE TRACT  
OFFICIAL RECORD 298, PAGE 736  
VIRGINIA MILITARY SURVEY 3326  
RUSHCREEK AND JEFFERSON TOWNSHIP  
LOGAN COUNTY, OHIO

SURVEYED BY:  
*Jeffrey L. Lee*  
JEFFREY L. LEE  
PROFESSIONAL SURVEYOR 6359  
SEPTEMBER 15, 1996  
DECEMBER 29, 1997



COPYRIGHT 1996 BY:  
LEE SURVEYING & MAPPING CO., INC.  
117 North Madison Street  
BELLEFONTAINE, OHIO 43311  
(937) 593-7335

2 WORKING DAYS  
BEFORE YOU DIG  
CALL TOLL FREE 800-362-2764  
OHIO UTILITIES PROTECTION SERVICE.

3389 9P

REC'D 1-9-98 SMJ OK ✓



# Lee Surveying and Mapping Co., Inc.



Farm Surveys • Lot Surveys • Topography • Subdivisions • Construction Layout

117 NORTH MADRIVER STREET  
BELLEFONTAINE, OHIO 43311

(937) 593-7335  
FAX (937) 593-7444

## BURKHOLDER 0.158 ACRE

Lying in Virginia Military Survey 3326, Rushcreek Township, Logan County, Ohio.

Being out of the Carl Burkholder and Rosetta Burkholder original 47.597 acre tract as deeded and described in Official Record 298, Page 736 of the Logan County Record of Deeds and being for highway right-of-way purposes and more particularly described as follows:

Beginning at a 1/2 inch square iron bar found on the center-line of Ohio Route 47 at the intersection with the center-line of County Highway 5.

THENCE, with the north line of the said 47.597 acre tract and within the right-of-way of Township Road 273, S 84°-20'-35" W, a distance of 747.31 feet to a railroad spike set at the TRUE POINT OF BEGINNING.

THENCE, with the west line of the Roger D. Kennard 1.027 acre tract, (O.R. 311, Pg. 370) S 4°-45'-42" E, a distance of 29.18 feet to a 5/8 inch iron rod set.

THENCE, parallel to and 30.00 feet distant from the center-line of Township Road 273 (50 feet wide) the following two courses:

S 83°-52'-52" W, a distance of 17.30 feet to a 5/8 inch iron rod set.

S 88°-10'-52" W, a distance of 363.14 feet to a 5/8 inch iron rod set on the east line of the Steven R. Gregg 57.55 acre tract, (O.R. 105, Pg. 556).

THENCE, with the east line of the said 57.55 acre tract, N 4°-45'-42" W, a distance of 5.01 feet to a 5/8 inch iron rod set.

THENCE, with the north line of the said original 47.597 acre tract and within the right-of-way of Township Road 273, N 84°-14'-00" E, a distance of 363.13 feet to a railroad spike set.

THENCE, with the north line of the said original 47.597 acre tract and within the right-of-way of Township Road 273, N 86°-41'-49" E, a distance of 16.88 feet to the point of beginning.

Containing 0.158 acre of which 0.114 acre is within the existing highway right-of-way.

The basis for bearings is the center-line of Ohio Route 47 south of the intersection with County Highway 5, being S 12°-58'-16" E, and all other bearings are from angles and distances measured in a field survey by Lee Surveying and Mapping Co., Inc. on December 29, 1997.

Description prepared by:

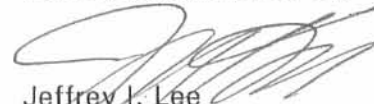
  
Jeffrey I. Lee  
Professional Surveyor 6359  
January 2, 1998



L-2450

ORIGINAL STAMP IN GREEN

INDEXED ON MAP  
3389 100-1

REC'D 1-15-98 SWM OK ✓



# Lee Surveying and Mapping Co., Inc.



Farm Surveys • Lot Surveys • Topography • Subdivisions • Construction Layout

117 NORTH MADRIVER STREET  
BELLEFONTAINE, OHIO 43311

(937) 593-7335  
FAX (937) 593-7444

## BURKHOLDER 0.108 ACRE

Lying in Virginia Military Survey 3326, Rushcreek Township, Logan County, Ohio.

Being out of the Roger D. Kennard 1.027 acre tract as deeded and described in Official Record 311, Page 370 of the Logan County Records of Deeds and being for highway right-of-way purposes and more particularly described as follows:

Beginning at a 1/2 inch square iron bar found on the center-line of Ohio Route 47 at the intersection with the center-line of County Highway 5.

THENCE, with the north line of the Carl Burkholder 47.597 acre tract, (O.R. 298, Pg. 736), and within the right-of-way of Township Road 273 (50 feet wide), S 84°-20'-35" W, a distance of 582.94 feet to a railroad spike set at the TRUE POINT OF BEGINNING.

THENCE, S 4°-45'-42" E, a distance of 27.85 feet to a 5/8 inch iron rod set.

THENCE, parallel to and 30.00 feet distant from the center-line of Township Road 273, S 83°-52'-52" W, a distance of 164.40 feet to a 5/8 inch iron rod set.

THENCE, N 4°-45'-42" W, a distance of 29.18 feet to a railroad spike set.

THENCE, with the north property line of the said 1.027 acre tract and within the right-of-way of Township Road 273, N 84°-20'-35" E, a distance of 164.37 feet to the point of beginning.

Containing 0.108 acre of which 0.089 acre is within the existing highway right-of-way.

The basis for bearings is the center-line of Ohio Route 47 south of the intersection with County Highway 5, being S 12°-58'-16" E, and all other bearings are from angles and distances measured in a field survey by Lee Surveying and Mapping Co., Inc. on December 29, 1997.

Description prepared by:

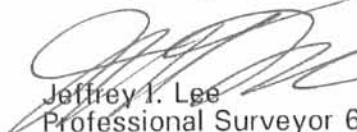
  
Jeffrey I. Lee  
Professional Surveyor 6359  
January 2, 1998



L-2450

ORIGINAL STAMP IN GREEN

INDEXED ON MAP  
338910D-2

REC'D 1-9-98 SWJ OK ✓



# Lee Surveying and Mapping Co., Inc.



Farm Surveys • Lot Surveys • Topography • Subdivisions • Construction Layout

117 NORTH MADRIVER STREET  
BELLEFONTAINE, OHIO 43311

(937) 593-7335  
FAX (937) 593-7444

## BURKHOLDER 0.578 ACRE

Lying in Virginia Military Survey 3326, Rushcreek Township, Logan County, Ohio.

Being out of the Carl Burkholder and Rosetta Burkholder original 47.597 acre tract as deeded and described in Official Record 298, Page 736 of the Logan County Record of Deeds and being for highway right-of-way purposes and more particularly described as follows:

Beginning at a 1/2 inch square iron bar found on the center-line of Ohio Route 47 at the intersection with the center-line of County Highway 5.

THENCE, with the center-line of Ohio Route 47, S 12°-58'-16" E, a distance of 361.66 feet to a railroad spike set.

THENCE, S 83°-52'-52" W, a distance of 30.22 feet to a 5/8 inch iron rod set on the southeast corner of the Roger D. Kennard 1.004 acre tract, (O.R. 311, Pg. 364).

THENCE, with the east line of the said 1.004 acre tract, and the east line of the Carl Burkholder 0.918 acre tract, (O.R. 312, Pg. 671A), N 12°-58'-16" W, a distance of 316.17 feet to a 5/8 inch iron rod set.

THENCE, continuing with the lines of the said 0.918 acre tract, a curve to the left having a central angle of 83°-08'-51", a radius of 25.00 feet, an arc length of 36.28 feet, and a chord bearing N 54°-32'-42" W, a distance of 33.18 feet to a 5/8 inch iron rod set.

THENCE, continuing with the north line of the said 0.918 acre tract and with the said line extended, parallel to and 30.00 feet distant from the center-line of Township Road 273 (50 feet wide), S 83°-52'-52" W, a distance of 533.97 feet to a 5/8 inch iron rod set.

THENCE, with an east line of the Roger D. Kennard 1.027 acre tract, (O.R. 311, Pg. 370), N 4°-45'-42" W, a distance of 27.85 feet to a railroad spike set.

THENCE, with the north line of the said original 47.597 acre tract and within the right-of-way of Township Road 273, N 84°-20'-35" E, a distance of 582.94 feet to the point of beginning.

Containing 0.578 acre of which 0.508 acre is within the existing highway right-of-way.

The basis for bearings is the center-line of Ohio Route 47 south of the intersection with County Highway 5, being S 12°-58'-16" E, and all other bearings are from angles and distances measured in a field survey by Lee Surveying and Mapping Co., Inc. on December 29, 1997.

Description prepared by:

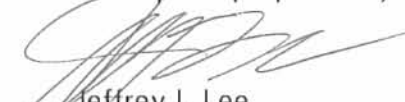
  
Jeffrey I. Lee  
Professional Surveyor 6359  
January 2, 1998



L-2450

3389 10D-3

ORIGINAL STAMP IN GREEN

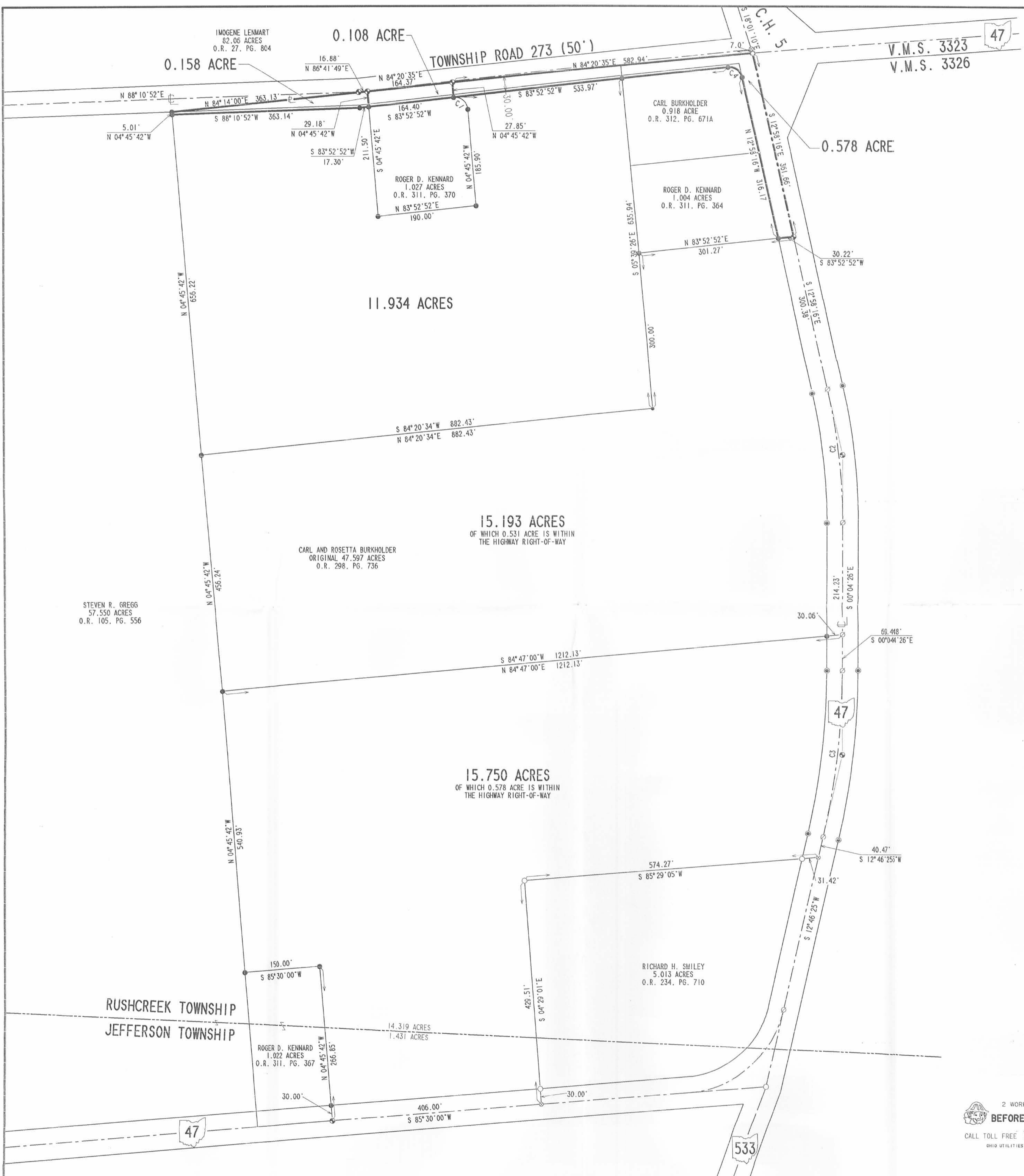

CURVE	DELTA ANGLE	RADIUS	ARC	TANGENT	CHORD	CHORD BEARING
C 1	91°21'26"	25.00'	39.86'	25.60'	35.77'	N 50°26'25"W
C 2	12°53'50"	1143.27'	257.35'	129.22'	256.80'	S 06°31'21"E
C 3	12°50'51"	1434.99'	321.77'	161.56'	321.10'	S 06°20'59"W
C 4	83°08'51"	25.00'	36.28'	22.18'	33.18'	N 54°32'42"W

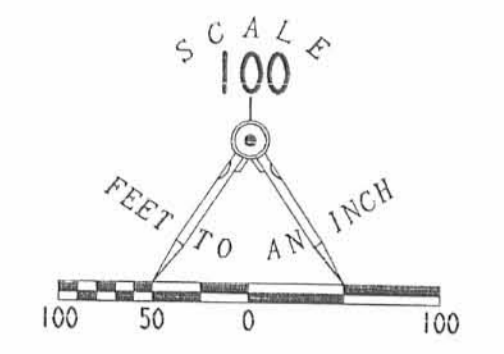

REFERENCES  
 LOGAN COUNTY ENGINEER'S FILES:  
 R-3447, R-3389, R-1703, R-2714, R-1377  
 R-5941, R-5534

- LEGEND
- 5/8" IRON ROD SET
  - 5/8" IRON ROD FOUND
  - ⊙ RAILROAD SPIKE SET
  - ⊗ RAILROAD SPIKE FOUND
  - ⊕ CONCRETE RIGHT OF WAY MONUMENT FOUND
  - 1/2" X 1/2" IRON BAR FOUND
  - ⊗ MAG NAIL SET

SURVEY FOR HIGHWAY PURPOSES  
 OUT OF THE ROGER D. KENNARD  
 1.027 ACRE TRACT  
 OFFICIAL RECORD 311, PAGE 370  
 AND OUT OF THE  
 CARL BURKHOLDER AND ROSETTA BURKHOLDER  
 ORIGINAL 47.597 ACRE TRACT  
 OFFICIAL RECORD 298, PAGE 736  
 VIRGINIA MILITARY SURVEY 3326  
 RUSHCREEK AND JEFFERSON TOWNSHIP  
 LOGAN COUNTY, OHIO

2 WORKING DAYS  
**BEFORE YOU DIG**  
 CALL TOLL FREE 800-362-2764  
 OHIO UTILITIES PROTECTION SERVICE.

INDEXED ON MAP  
 3307 10P

SURVEYED BY:  
  
 JEFFREY L. LEE  
 PROFESSIONAL SURVEYOR 6359  
 DECEMBER 23, 1997

COPYRIGHT 1998 BY:  
**LEE SURVEYING & MAPPING CO., INC.**  
 117 North Madriver Street  
 BELLEFONTAINE, OHIO 43311  
 (937) 593-7335

ORIGINAL STAMP IN GREEN  
 D 287 LOGRUNRW L-2450-1



Rec'd 11-29-00 Sully OK ✓

# Lee Surveying and Mapping Co., Inc.

Land Surveys • Topography • Subdivisions • Construction Layout

117 N. Madriver St.  
Bellefontaine OH 43311



Phone: (937) 593-7335  
Fax: (937) 593-7444

## BURKHOLDER TRACT M-3 4.278 ACRES

Lying in Virginia Military Survey 3326, Rushcreek and Jefferson Townships, Logan County, Ohio.

Being out of the Carl Burkholder original 10.200 acre tract as deeded and described in Official Record 382, Page 284 of the Logan County Records of Deeds and being more particularly described as follows:

Beginning at a 5/8 inch iron rod found at the intersection of the center-lines of Ohio Route 47 and Ohio Route 533.

THENCE, with the center-line of Ohio Route 47, S 85°-30'-00" W, a distance of 440.78 feet to a railroad spike found at the TRUE POINT OF BEGINNING.

THENCE, continuing with the center-line of Ohio Route 47, S 85°-30'-00" W, a distance of 91.00 feet to a MAG nail set.

THENCE, N 4°-45'-42" W, a distance of 150.00 feet to a 5/8 inch iron rod set, passing a 5/8 inch iron rod set at 30.00 feet.

THENCE, N 23°-13'-36" W, a distance of 80.00 feet to a 5/8 inch iron rod set.

THENCE, N 41°-00'-22" W, a distance of 130.00 feet to a 5/8 inch iron rod set.

THENCE, N 60°-13'-13" W, a distance of 68.00 feet to a 5/8 inch iron rod set.

THENCE, N 25°-22'-52" W, a distance of 281.34 feet to a 5/8 inch iron rod set.

THENCE, N 9°-05'-54" W, a distance of 112.00 feet to a 5/8 inch iron rod set.

THENCE, N 18°-46'-11" W, a distance of 99.99 feet to a 5/8 inch iron rod set.

THENCE, with the south line of the Carl Burkholder original 5.389 acre tract (O.R. 382, Pg. 282), N 84°-47'-00" E, a distance of 308.53 feet to a 5/8 inch iron rod set.

THENCE, S 5°-23'-09" E, a distance of 210.00 feet to a 5/8 inch iron rod set.

THENCE, N 84°-47'-00" E, a distance of 70.00 feet to a 5/8 inch iron rod set.

INDEXED ON MA  
3389 112

# Lee Surveying and Mapping Co., Inc.

Land Surveys • Topography • Subdivisions • Construction Layout

117 N. Madriver St.  
Bellefontaine OH 43311



Phone: (937) 593-7335  
Fax: (937) 593-7444

THENCE, with the west line of the Carl Burkholder original 6.026 acre tract (O.R. 382, Pg. 280), S 5°-23'-09" E, a distance of 205.24 feet to a 5/8 inch iron rod found.

THENCE, with the west line of the Richard H. Smiley 5.013 acre tract (O.R. 234, Pg. 710), S 4°-29'-01" E, a distance of 429.51 feet to the place of beginning, passing a 5/8 inch iron rod found at 399.51 feet.

Containing 4.278 acres of which 0.063 acre is within the highway right-of-way. 3.998 acres are in Rushcreek Township and 0.280 acre is in Jefferson Township.

The basis for bearings is the center-line of Ohio Route 47 being S 85°-30'-00" W, and all other bearings are from angles and distances measured in a field survey by Lee Surveying and Mapping Co., Inc. on October 20, 2000.

Description prepared by:

A handwritten signature in black ink, appearing to read 'J. Lee', is written over the printed name and title.

Jeffrey I. Lee  
Professional Surveyor 6359  
Revised november 18, 2000



ORIGINAL STAMP IN GREEN L-2450

INDEXED ON MAP  
3389 IID:2

REC'D 11-27-00 SWY OK ✓

# Lee Surveying and Mapping Co., Inc.

Land Surveys • Topography • Subdivisions • Construction Layout

117 N. Madriver St.  
Bellefontaine OH 43311



Phone: (937) 593-7335  
Fax: (937) 593-7444

## BURKHOLDER TRACT K-3 3.458 ACRES

Lying in Virginia Military Survey 3326, Rushcreek Township, Logan County, Ohio.

Being out of the Carl Burkholder original 6.026 acre tract as deeded and described in Official Record 382, Page 280 and the original 10.200 acre tract as deeded and described in Official Record 382, Page 284 of the Logan County Records of Deeds and being more particularly described as follows:

Beginning at a 5/8 inch iron rod found at the intersection of the center-lines of Ohio Route 47 and Ohio Route 533.

THENCE, with the center-line of Ohio Route 47, N 12°-46'-25" E, a distance of 490.42 feet to a MAG nail found at P.C. Station 1060 + 50.69 of the Logan County Engineer's files.

THENCE, continuing with the center-line of Ohio Route 47 and a curve to the left with a central angle of 4°-36'-15", a radius of 1434.99 feet, an arc length of 115.31, a tangent of 57.69 feet, a chord length of 115.28 feet and a chord bearing N 10°-28'-18" E to a MAG nail set.

THENCE, continuing with the center-line of Ohio Route 47 and a curve to the left with a central angle of 2°-33'-52", a radius of 1434.99 feet, an arc length of 64.23, a tangent of 32.12 feet, a chord length of 64.22 feet and a chord bearing N 6°-53'-12" E to a MAG nail set at the TRUE POINT OF BEGINNING.

THENCE, S 84°-47'-00" W, a distance of 701.97 feet to a 5/8 inch iron rod set, passing a 5/8 inch iron rod set at 30.56 feet.

THENCE, N 5°-23'-09" W, a distance of 210.00 feet to a 5/8 inch iron rod set.

THENCE, with the south line of the Carl Burkholder original 5.389 acre tract (O.R. 382, Pg. 282), N 84°-47'-00" E, a distance of 728.56 feet to a MAG nail found, passing a 5/8 inch iron rod found at 698.50 feet.

THENCE, with the center-line of Ohio Route 47 the following two courses:

S 00°-04'-26" E, a distance of 69.48 feet to a MAG nail found at P.T. Station 1063 + 72.36.

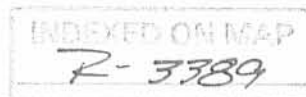

# Lee Surveying and Mapping Co., Inc.

Land Surveys • Topography • Subdivisions • Construction Layout

117 N. Madriver St.  
Bellefontaine OH 43311



Phone: (937) 593-7335  
Fax: (937) 593-7444

With a curve to the right with a central angle of  $5^{\circ}-40'-44''$ , a radius of 1434.99 feet, an arc length of 142.23, a tangent of 71.17 feet, a chord length of 142.17 feet and a chord bearing  $S 2^{\circ}-45'-56'' W$  to the place of beginning.

Containing 3.458 acres of which 0.146 acre is within the highway right-of-way.

The basis for bearings is the center-line of Ohio Route 47 being  $S 85^{\circ}-30'-00'' W$ , and all other bearings are from angles and distances measured in a field survey by Lee Surveying and Mapping Co., Inc. on October 20, 2000.

Description prepared by:

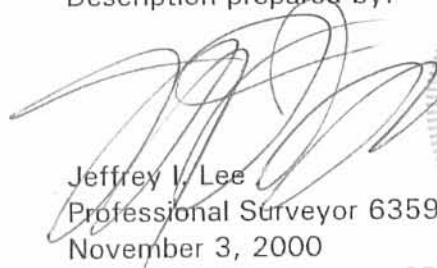
  
Jeffrey I. Lee  
Professional Surveyor 6359  
November 3, 2000



ORIGINAL STAMP IN GREEN L-2450

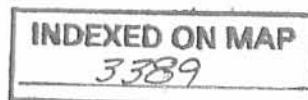

11D-4

REC'D 11-27-00 SMY OK ✓  
**Lee Surveying and Mapping Co., Inc.**

Land Surveys • Topography • Subdivisions • Construction Layout

117 N. Madriver St.  
Bellefontaine OH 43311



Phone: (937) 593-7335  
Fax: (937) 593-7444

**BURKHOLDER  
TRACT P-3  
1.880 ACRES**

Lying in Virginia Military Survey 3326, Rushcreek Township, Logan County, Ohio.

Being out of the Carl Burkholder original 6.026 acre tract as deeded and described in Official Record 382, Page 280 of the Logan County Records of Deeds and being more particularly described as follows:

Beginning at a 5/8 inch iron rod found at the intersection of the center-lines of Ohio Route 47 and Ohio Route 533.

THENCE, with the center-line of Ohio Route 47, N 12°-46'-25" E, a distance of 490.42 feet to a MAG nail found at P.C. Station 1060+50.69 of the Logan County Engineer's files.

THENCE, continuing with the center-line of Ohio Route 47 and a curve to the left with a central angle of 4°-36'-15", a radius of 1434.99 feet, an arc length of 115.31, a tangent of 57.69 feet, a chord length of 115.28 feet and a chord bearing N 10°-28'-18" E to a MAG nail set at the TRUE POINT OF BEGINNING.

THENCE, with the lines of the Carl Burkholder 1.026 acre tract (O.R. 404, Pg. 618), the following two courses:

S 85°-29'-05" W, a distance of 317.55 feet to a 5/8 inch iron rod set, passing a 5/8 inch iron rod set at 30.77 feet.

S 4°-30'-55" E, a distance of 150.00 feet to a 5/8 inch iron rod set.

THENCE, with the north line of the Richard H. Smiley 5.013 acre tract (O.R. 234, Pg. 710), S 85°-29'-05" W, a distance of 298.56 feet to a 5/8 inch iron rod found.

THENCE, with the east line of the Carl Burkholder original 10.200 acre tract (O.R. 382, Pg. 284), N 5°-23'-09" W, a distance of 205.24 feet to a 5/8 inch iron rod set.

THENCE, N 84°-47'-00" E, a distance of 631.97 feet to a MAG nail set, passing a 5/8 inch iron rod set at 601.41 feet.

THENCE, with the center-line of Ohio Route 47 with a curve to the left with a central angle of 2°-33'-52", a radius of 1434.99 feet, an arc length of 64.23, a tangent of 32.12 feet, a chord length of 64.22 feet and a chord bearing S 6°-53'-12" W to the place of beginning

INDEXED ON MAP  
J389 110-5

# Lee Surveying and Mapping Co., Inc.

Land Surveys • Topography • Subdivisions • Construction Layout

117 N. Madriver St.  
Bellefontaine OH 43311



Phone: (937) 593-7335  
Fax: (937) 593-7444

Containing 1.880 acres of which 0.044 acre is within the highway right-of-way.

The basis for bearings is the center-line of Ohio Route 47 being S 85°-30'-00" W, and all other bearings are from angles and distances measured in a field survey by Lee Surveying and Mapping Co., Inc. on October 20, 2000.

Description prepared by:

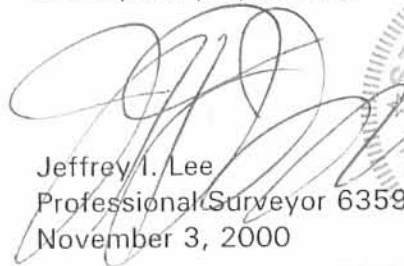
  
Jeffrey I. Lee  
Professional Surveyor 6359  
November 3, 2000

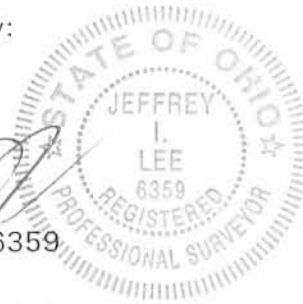

ORIGINAL STAMP IN GREEN

L-2450

INDEXED ON MAP  
R-3389 11D-6

IMOGENE LENHART  
82.06 ACRES  
O.R. 27, PG. 804

V.M.S. 3323  
V.M.S. 3326

47

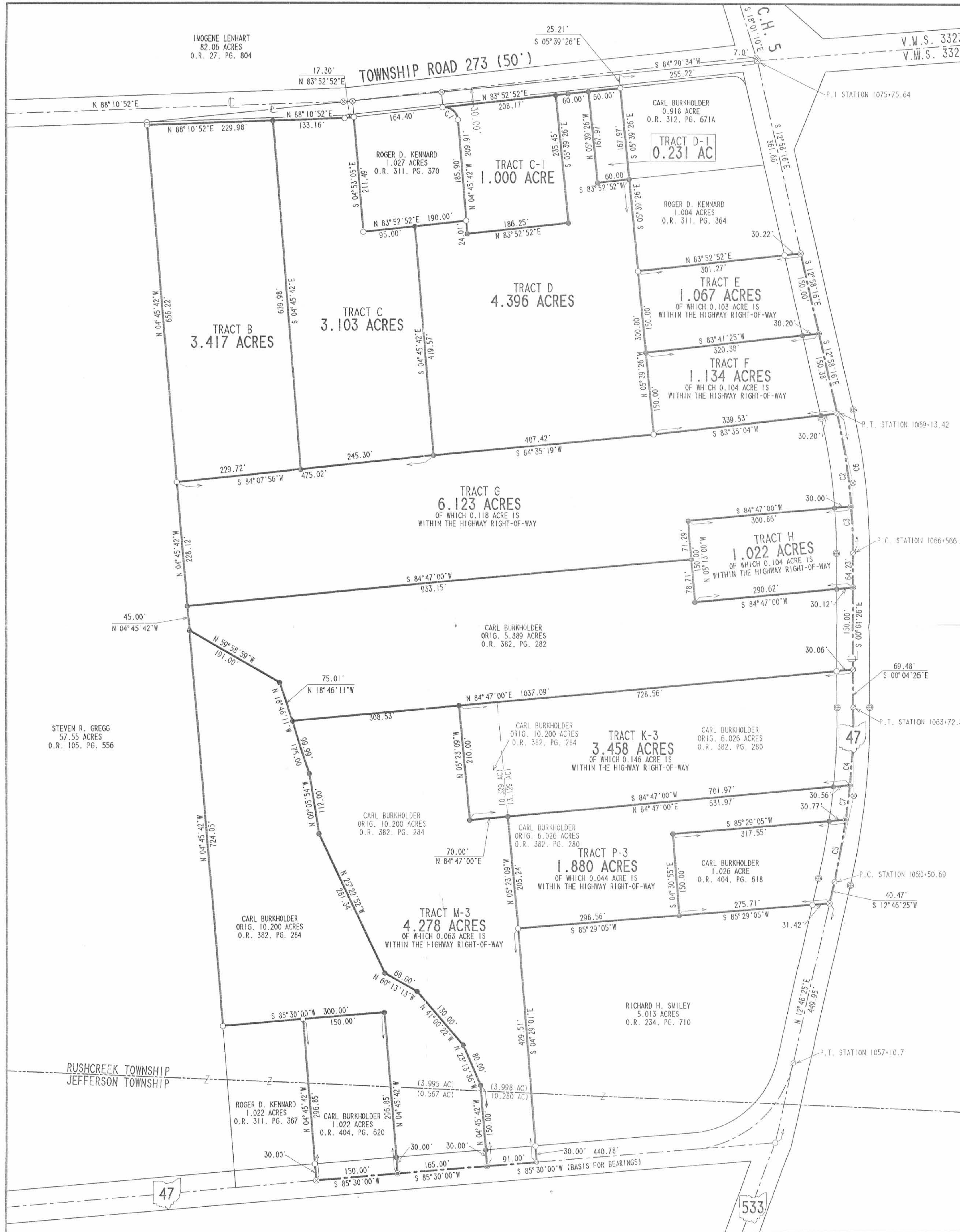

CURVE	DELTA ANGLE	RADIUS	ARC	TANGENT	CHORD	CHORD BEARING
C 1	91°21'26"	25.00'	39.86'	25.60'	35.77'	N 50°26'25"W
C 2	8°34'45"	1143.27'	171.19'	85.75'	171.02'	S 08°40'52"E
C 3	4°19'05"	1143.27'	86.16'	43.10'	86.14'	S 02°14'01"E
C 4	5°40'44"	1434.99'	142.23'	71.17'	142.17'	S 02°45'56"W
C 5	4°36'15"	1434.99'	115.31'	57.69'	115.28'	S 10°28'18"W
C 6	12°53'50"	1143.27'	257.35'	129.22'	256.80'	S 6°31'21"E
C 7	2°33'52"	1434.99'	64.23'	32.12'	64.22'	S 06°53'12"W

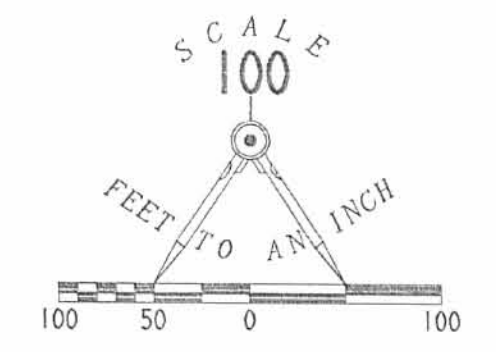

- LEGEND
- 5/8" IRON ROD SET
  - 5/8" IRON ROD FOUND
  - ⊙ MAG NAIL SET
  - ⊗ RAILROAD SPIKE FOUND
  - ⊕ CONCRETE RIGHT OF WAY MONUMENT FOUND
  - ⊠ 1/2 INCH x 1/2 INCH IRON BAR FOUND
  - ⊙ MAG NAIL FOUND

REFERENCES  
LOGAN COUNTY ENGINEER'S FILES:  
R-3447, R-3389, R-1703, R-2714, R-1377  
R-5941, R-5534

# ROSE ESTATES

SURVEY OF TRACTS K-3, M-3 AND P-3 OUT OF THE  
CARL BURKHOLDER  
ORIGINAL 10.200 ACRE TRACT  
OFFICIAL RECORD 382, PAGE 284  
AND THE ORIGINAL 6.026 ACRE TRACT  
OFFICIAL RECORD 382, PAGE 280  
VIRGINIA MILITARY SURVEY 3326  
RUSHCREEK AND JEFFERSON TOWNSHIPS  
LOGAN COUNTY, OHIO



SURVEYED BY:  
*Jeffrey L. Lee*  
JEFFREY L. LEE  
PROFESSIONAL SURVEYOR 6359  
MAY 1, 1998  
AMENDED: TRACT K-3, TRACT M-3 AND TRACT P-3  
OCTOBER 20, 2000

2 WORKING DAYS  
BEFORE YOU DIG  
CALL TOLL FREE 800-362-2764  
OHIO UTILITIES PROTECTION SERVICE.

COPYRIGHT 2000 BY:  
LEE SURVEYING & MAPPING CO., INC.  
117 North Madison Street  
BELLERFONTAINE, OHIO 43311  
(937) 593-7335

D-388 LOGRUN16.GCD L-2450-1  
LOGRUNB.DAT

INDEXED ON MAP  
3389 JIP

REC'D 0-1-98 SMY OK ✓



# Lee Surveying and Mapping Co., Inc.



Land Surveys • Topography • Subdivisions • Construction Layout

117 N. Madriver Street  
Bellefontaine OH 43311

Phone: (937) 593-7335  
Fax: (937) 593-7444

## BURKHOLDER TRACT A-1 4.164 ACRES

Lying in Virginia Military Survey 3326, Rushcreek Township, Logan County, Ohio.

Being out of the Carl Burkholder and Rosetta Burkholder original 47.597 acre tract as deeded and described in Official Record 298, Page 736 of the Logan County Records of Deeds and being more particularly described as follows:

Beginning at a 1/2 inch square iron bar found on the center-line of Ohio Route 47 at the intersection with the center-line of County Highway 5.

THENCE, with the north line of the said 47.597 acre tract and within the right-of-way of Township Road 273, S 84°-20'-34" W, a distance of 255.22 feet to a point.

THENCE, with the west line extended and the west line of the Carl Burkholder 0.918 acre tract, (O.R. 312, Pg. 671A), S 5°-39'-26" E, a distance of 193.18 to a 5/8 inch iron rod set at the TRUE POINT OF BEGINNING, passing a 5/8 inch iron rod found at 25.21 feet and 30.00 feet south of the center-line of Township Road 273 (currently 50 feet wide).

THENCE, with the west lines of the Roger D. Kennard 1.004 acre tract (O.R. 311, Pg. 364) and said west line extended, S 5°-39'-26" E, a distance of 467.97 feet to a 5/8 inch iron rod found.

THENCE, S 84°-35'-19" W, a distance of 407.42 feet to a 5/8 inch iron rod set.

THENCE, N 4°-45'-42" W, a distance of 419.57 feet to a 5/8 inch iron rod set.

THENCE, with the south line of the Roger D. Kennard 1.027 acre tract (O.R. 311, Pg. 370), N 83°-52'-52" E, a distance of 95.00 feet to a 5/8 inch iron rod found.

THENCE, S 4°-45'-42" E, a distance of 24.01 feet to a 5/8 inch iron rod set.

THENCE, N 83°-52'-52" E, a distance of 186.25 feet to a 5/8 inch iron rod set.

THENCE, N 5°-39'-26" W, a distance of 235.45 feet to a 5/8 inch iron rod set.

THENCE, parallel and 30.00 feet south of the center-line of Township Road 273, N 83°-52'-52" E, a distance of 60.00 feet to a 5/8 inch iron rod set.

THENCE, S 5°-39'-26" E, a distance of 167.97 feet to a 5/8 inch iron rod set.

THENCE, N 83°-52'-52" E, a distance of 60.00 feet to the point of beginning.

Containing 4.164 acres.

The basis for bearings is the center-line of Ohio Route 47 west of the intersection with the center-line of Ohio Route 533, being S 85°-30'-00" W, and all other bearings are from angles and distances measured in a field survey by Lee Surveying and Mapping Co., Inc. on May 1, 1998.

Description prepared by:

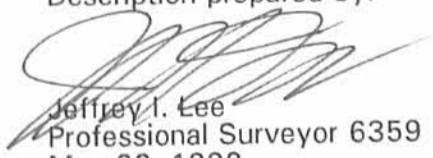
  
Jeffrey I. Lee  
Professional Surveyor 6359  
May 22, 1998

Revised September 30, 1998

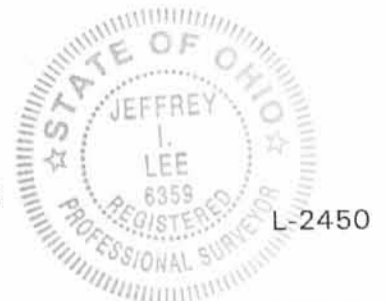

ORIGINAL STAMP IN GREEN

INDEXED ON MAP  
3389 12D-1



REC'D 7-31-98 GMY OK ✓



# Lee Surveying and Mapping Co., Inc.



Land Surveys • Topography • Subdivisions • Construction Layout

117 N. Madriver Street  
Bellefontaine OH 43311

Phone: (937) 593-7335  
Fax: (937) 593-7444

## TRACT B-1 6.520 ACRES

Lying in Virginia Military Survey 3326, Rushcreek Township, Logan County, Ohio.

Being out of the Carl Burkholder and Rosetta Burkholder original 47.597 acre tract as deeded and described in Official Record 298, Page 736 of the Logan County Records of Deeds and being more particularly described as follows:

Beginning at a 1/2 inch square iron bar found on the center-line of Ohio Route 47 at the intersection with the center-line of County Highway 5.

THENCE, with the north line of the said 47.597 acre tract and within the right-of-way of Township Road 273, S 84°-20'-34" W, a distance of 255.22 feet to a point.

THENCE, S 5°-39'-26" E, a distance of 25.21 feet to a 5/8 inch iron rod found 30.00 feet south of the center-line of Township Road 273 (currently 50 feet wide).

THENCE, parallel and 30.00 feet distant from the center-line of Township Road 273, S 83°-52'-52" W, a distance of 492.57 feet to a 5/8 inch iron rod found at the TRUE POINT OF BEGINNING.

THENCE, with the lines of the Roger D. Kennard 1.027 acre tract (O.R. 311, Pg. 370) the following two courses:

S 4°-45'-42" E, a distance of 211.49 feet to a 5/8 inch iron rod found.

N 83°-52'-52" E, a distance of 95.00 feet to a 5/8 inch iron rod set.

THENCE, S 4°-45'-42" E, a distance of 419.57 feet to a 5/8 inch iron rod set.

THENCE, S 84°-07'-56" W, a distance of 475.02 feet to a 5/8 inch iron rod found.

THENCE, with the east line of the Steven R. Gregg 57.55 acre tract (O.R. 105, Pg. 556) N 4°-45'-42" W, a distance of 656.22 feet to a 5/8 inch iron rod found.

THENCE, 30 feet distant and parallel to the center-line of Township Road 273, N 88°-10'-52" E, a distance of 363.14 feet to a 5/8 inch iron rod found.

THENCE N 83°-52'-52" E, a distance of 17.30 feet to the point of beginning.

Containing 6.520 acres.

The basis for bearings is the center-line of Ohio Route 47 west of the intersection with the center-line of Ohio Route 533, being S 85°-30'-00" W, and all other bearings are from angles and distances measured in a field survey by Lee Surveying and Mapping Co., Inc. on May 1, 1998.

Description prepared by:

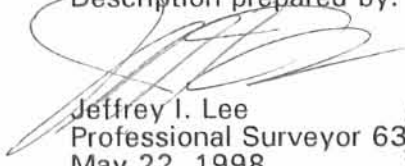
  
Jeffrey I. Lee  
Professional Surveyor 6359  
May 22, 1998

RCV. 7-30-98



L-2450

ORIGINAL STAMP IN GREEN

INDEXED ON MAP  
3389 12D-2

REC ID 8-12-98 original



# Lee Surveying and Mapping Co., Inc.



Land Surveys • Topography • Subdivisions • Construction Layout

117 N. Madriver Street  
Bellefontaine OH 43311

Phone: (937) 593-7335  
Fax: (937) 593-7444

## BURKHOLDER TRACT C-1 1.000 ACRES

Lying in Virginia Military Survey 3326, Rushcreek Township, Logan County, Ohio.

Being out of the Carl Burkholder and Rosetta Burkholder original 47.597 acre tract as deeded and described in Official Record 298, Page 736 of the Logan County Records of Deeds and being more particularly described as follows:

Beginning at a 1/2 inch square iron bar found on the center-line of Ohio Route 47 at the intersection with the center-line of County Highway 5.

THENCE, with the north line of the said 47.597 acre tract and within the right-of-way of Township Road 273, S 84°-20'-34" W, a distance of 255.22 feet to a point.

THENCE, S 5°-39'-26" E, a distance of 25.21 feet to a 5/8 inch iron rod found 30.00 feet south of the center-line of Township Road 273 (currently 50 feet wide).

THENCE, parallel and 30.00 feet distant from the center-line of Township Road 273, S 83°-52'-52" W, a distance of 120.00 feet to a 5/8 inch iron rod set at the TRUE POINT OF BEGINNING.

THENCE, S 5°-39'-26" E, a distance of 235.45 feet to a 5/8 inch iron rod set.

THENCE, S 83°-52'-52" W, a distance of 186.25 feet to a 5/8 inch iron rod set.

THENCE, with the east line extended and the east line of the Roger D. Kennard 1.027 acre tract, (O.R. 311, Pg. 370), N 4°-45'-42" W, a distance of 209.91 feet to a 5/8 inch iron rod found.

THENCE, with a curve to the left having a central angle of 91°-21'-26", a radius of 25.00 feet, an arc length of 39.86 feet, and a chord bearing N 50°-26'-25" W, a distance of 35.77 feet to a 5/8 inch iron rod found.

THENCE, parallel and 30 feet distant from the center-line of Township Road 273, N 83°-52'-52" E, a distance of 208.17 feet to the point of beginning.

Containing 1.000 acres.

The basis for bearings is the center-line of Ohio Route 47 west of the intersection with the center-line of Ohio Route 533, being S 85°-30'-00" W, and all other bearings are from angles and distances measured in a field survey by Lee Surveying and Mapping Co., Inc. on May 1, 1998.

Description prepared by:

  
Jeffrey I. Lee  
Professional Surveyor 6359  
May 22, 1998



L-2450

ORIGINAL STAMP IN GREEN

INDEXED ON MAP  
3389 12D-3



# Lee Surveying and Mapping Co., Inc.



Land Surveys • Topography • Subdivisions • Construction Layout

117 N. Madriver Street  
Bellefontaine OH 43311

Phone: (937) 593-7335  
Fax: (937) 593-7444

## BURKHOLDER TRACT D-1 0.231 ACRES

Lying in Virginia Military Survey 3326, Rushcreek Township, Logan County, Ohio.

Being out of the Carl Burkholder and Rosetta Burkholder original 47.597 acre tract as deeded and described in Official Record 298, Page 736 of the Logan County Records of Deeds and being more particularly described as follows:

Beginning at a 1/2 inch square iron bar found on the center-line of Ohio Route 47 at the intersection with the center-line of County Highway 5.

THENCE, with the north line of the said 47.597 acre tract and within the right-of-way of Township Road 273, S 84°-20'-34" W, a distance of 255.22 feet to a point.

THENCE, S 5°-39'-26" E, a distance of 25.21 feet to a 5/8 inch iron rod found 30.00 feet south of the center-line of Township Road 273, (currently 50 feet wide), at the TRUE POINT OF BEGINNING.

THENCE, with the west line of the Carl Burkholder 0.918 acre tract, (O.R. 312, Pg. 671A), S 5°-39'-26" E, a distance of 167.97 to a 5/8 inch iron rod set.

THENCE, S 83°-52'-52" W, a distance of 60.00 feet to a 5/8 inch iron rod set.

THENCE, N 5°-39'-26" W, a distance of 167.97 feet to a 5/8 inch iron rod set.

THENCE, parallel and 30.00 feet south of the center-line of Township Road 273, N 83°-52'-52" E, a distance of 60.00 feet to the point of beginning.

Containing 0.231 acre.

The basis for bearings is the center-line of Ohio Route 47 west of the intersection with the center-line of Ohio Route 533, being S 85°-30'-00" W, and all other bearings are from angles and distances measured in a field survey by Lee Surveying and Mapping Co., Inc. on May 1, 1998.

Description prepared by:

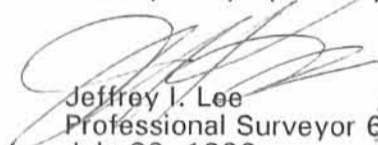
  
Jeffrey I. Lee  
Professional Surveyor 6359  
July 30, 1998

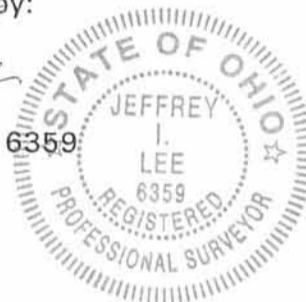

L-2450

ORIGINAL STAMP IN GREEN

INDEXED ON MAP  
3389 12D-4

IMOGENE LENMART  
82.06 ACRES  
O.R. 27. PG. 804

TOWNSHIP ROAD 273 (50')

V.M.S. 3323  
V.M.S. 3326

CURVE	DELTA ANGLE	RADIUS	ARC	TANGENT	CHORD	CHORD BEARING
C 1	91°21'26"	25.00'	39.86'	25.60'	35.77'	N 50°26'25"W
C 2	12°53'50"	1143.27'	257.35'	129.22'	256.80'	S 6°31'21"E
C 3	12°50'51"	1434.99'	315.04'	158.19'	314.38'	S 06°20'59"W

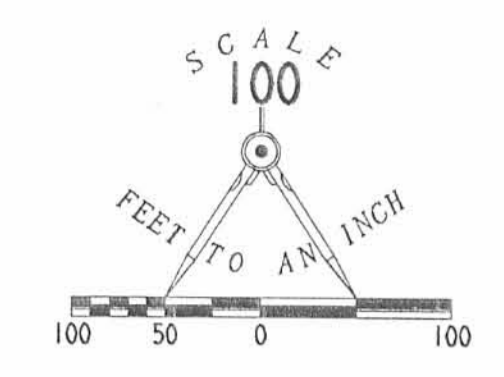

REFERENCES  
LOGAN COUNTY ENGINEER'S FILES:  
R-3447, R-3389, R-1703, R-2714, R-1377  
R-5941, R-5534

- LEGEND
- 5/8" IRON ROD SET
  - 5/8" IRON ROD FOUND
  - MAG NAIL SET
  - ⊙ RAILROAD SPIKE FOUND
  - ⊙ CONCRETE RIGHT OF WAY MONUMENT FOUND
  - 1/2" SQUARE IRON BAR FOUND
  - ⊙ MAG NAIL FOUND

STEVEN R. GREGG  
57.55 ACRES  
O.R. 105. PG. 556

TRACT B-1  
6.520 ACRES

TRACT C-1  
1.000 ACRE

TRACT D-1  
0.231 AC

TRACT A-1  
4.164 ACRES

TRACT E-1  
9.346 ACRES  
OF WHICH 0.420 ACRE IS  
WITHIN THE HIGHWAY RIGHT-OF-WAY

TRACT J  
5.389 ACRES  
OF WHICH 0.103 ACRE IS  
WITHIN THE HIGHWAY RIGHT-OF-WAY

TRACT K-1  
6.026 ACRES  
OF WHICH 0.297 ACRE IS  
WITHIN THE HIGHWAY RIGHT-OF-WAY

TRACT M-1  
9.178 ACRES  
OF WHICH 0.177 ACRE IS  
WITHIN THE HIGHWAY RIGHT-OF-WAY

TRACT P  
1.022 ACRES  
OF WHICH 0.103 ACRE IS  
WITHIN THE HIGHWAY RIGHT-OF-WAY

RICHARD H. SMILEY  
5.013 ACRES  
O.R. 234. PG. 710

SURVEY OF 9 TRACTS OUT OF THE  
CARL BURKHOLDER AND ROSETTA BURKHOLDER  
ORIGINAL 47.597 ACRE TRACT  
OFFICIAL RECORD 298, PAGE 736  
VIRGINIA MILITARY SURVEY 3326  
RUSHCREEK AND JEFFERSON TOWNSHIP  
LOGAN COUNTY, OHIO

INDEXED ON MAP  
3389 12P



SURVEYED BY:  
*Jeffrey I. Lee*  
JEFFREY I. LEE  
PROFESSIONAL SURVEYOR 6359  
JULY 30, 1998  
COPYRIGHT 1998 BY:  
LEE SURVEYING & MAPPING CO., INC.  
117 North Madriver Street  
BELLEFONTAINE, OHIO 43311  
(937) 593-7335

2 WORKING DAYS  
BEFORE YOU DIG  
CALL TOLL FREE 800-362-2764  
OHIO UTILITIES PROTECTION SERVICE.