

REC'D 7-29-08 *smg*

SURVEY FOR ELDEN ACRES

299.242 Acres

June 25, 2008

The following described 299.242 acre tract of land is situated in the State of Ohio, County of Logan, Townships of McArthur and Washington, McPherson Section, Town 7, Range 9 of the Congress Lands, and being part of Elden Acres, LLC's 478.87 acre Parcel One described in Official Record 885, page 556, and said 299.242 acre tract being more particularly described as follows:

Beginning at a $\frac{3}{4}$ inch iron bolt found at the intersection of the centerline of County Highway 91 (50 feet wide) with the centerline of Township Highway 33 (60 feet wide), said bolt being in the west line of the McPherson Section and said 478.87 acre tract and in the east line of Fractional Section 19, Town 7, Range 9, and marking the **place of beginning**;

Thence **North 20°11'45" West (assumed bearing) 610.96 feet**, following the east line of said Section 19, the west line of the McPherson Section, and the west line of said 478.87 acre tract, running parallel 5.00 feet east of the relocated centerline of County Highway 91 as shown in Logan County Engineer's Field Book 552, page 45, to a stone found at the southeast corner of Aubrey L. Daniel and Dwight D. Daniel's first described one acre tract described in Deed Record 352, page 470;

Thence **North 19°42'44" West 2326.71 feet**, departing from the centerline of County Highway 91, following the east line of said Section 19, the west line of the McPherson Section, the east line of said Daniel's first described one acre tract, the east line of Aubrey L. Daniel and Dwight D. Daniel's second described one acre tract described in Deed Record 352, page 470, the east line of Robert S. and Betty J. Stemple's 39.51 acre Parcel II, Tract I described in Official Record 108, page 864, and an east line of Robert S. and Betty J. Stemple's 66.45 acre Parcel II, Tract IV described in Official Record 108, page 864, passing at 43.67 feet an iron pin set, to a stone found at the northwest corner the McPherson Section and said 478.87 acre tract;

Thence **North 82°32'14" East 1103.66 feet**, following the north line of the McPherson Section and said 478.87 acre tract, the south line of said Fractional Section 19, a south line of said 66.45 acre tract, and the south line of Kevin E. Russell and Christina S. Russell's 30.175 acre tract described in Official Record 773, page 745, to a $\frac{5}{8}$ inch iron pin found at the southwest corner of Brian Knief's 86.36 acre Tract I, described in Official Record 407, page 775;

Thence **North 82°06'14" East 2031.19 feet**, following the north line of the McPherson Section and said 478.87 acre tract, the south line of said Fractional Section 19 and said 86.36 acre tract, departing from Washington Township and entering McArthur Township, to a $\frac{5}{8}$ inch iron pin found at a west corner of Lapama'a, LLC's original 475.405 acre tract described in Official Record 421, page 449;

Thence **North 82°06'14" East 844.60 feet**, following the north line of the McPherson Section and said 478.87 acre tract, the south line of said Fractional Section 19, the south line of Fractional Section 20, Town 7, Range 9, and a south line of said original 475.405 acre tract, to a



5/8 inch iron pin found at the northwest corner of Phyllis B. Yeasel, Trustee's 160.00 acre Tract VI described in Official Record 433, page 45;

Thence **South 19°43'05" East 3769.99 feet**, entering the McPherson Section and following the east line of said 478.87 acre tract and the west line of said 160.00 acre tract, passing at 2380.35 feet a 10 inch concrete post found leaning northeast (base of post being on property line), and passing at 3748.24 feet a 5/8 inch iron pin set, to a magnetic nail set in the centerline of County Highway 91;

Thence **North 86°35'48" West 2566.30 feet**, following the centerline of County Highway 91 and entering said 478.87 acre tract, to a 3/4 inch iron bolt found at an angle point in the centerline of County Highway 91;

Thence **North 86°44'21" West 1660.00 feet**, following the centerline of County Highway 91, departing from McArthur Township and entering Washington Township, passing at 582.61 feet a magnetic nail set, to the **place of beginning, containing 299.242 acres**, more or less, and being subject to all valid easements and restrictions of record.

Of the above described 299.242 acre tract, 2.710 acre is within the right of way of County Highway 91, 139.823 acres are in Washington Township, and 159.419 acres are in McArthur Township.

The above description was prepared based on an actual field survey made under the supervision of Paul R. Clapsaddle, Registered Surveyor #6140, during the month of June 2008. Iron pins set are 5/8 inch by 30 inch reinforcing rods with caps marked "CLAPSADDLE RS #6140." Bearings indicated herein are based on an assumed meridian and are to denote angles only.

ATTEST:

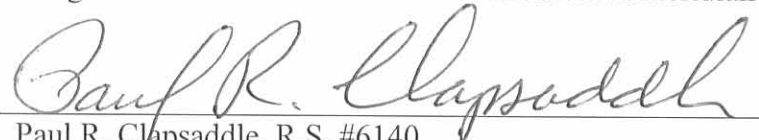

Paul R. Clapsaddle, R.S. #6140
19019 West Darby Road
Marysville, Ohio 43040
(937) 747-2599



REC'D 7-29-08 SMY OK

SURVEY FOR ELDEN ACRES
139.449 Acres
June 25, 2008

The following described 139.449 acre tract of land is situated in the State of Ohio, County of Logan, Townships of McArthur and Washington, McPherson Section, Town 7, Range 9 of the Congress Lands, and being part of Elden Acres, LLC's 478.87 acre Parcel One described in Official Record 885, page 556, said 139.449 acre tract being more particularly described as follows:

Beginning at a 3/4 inch iron bolt found at the intersection of the centerline of County Highway 91 (50 feet wide) with the centerline of Township Highway 33 (60 feet wide), said bolt being in the west line of the McPherson Section and said 478.87 acre tract and in the east line of Fractional Section 19, Town 7, Range 9;

Thence South 86°44'21" East (assumed bearing) 1077.39 feet, following the centerline of County Highway 91, entering the McPherson Section and said 478.87 acre tract, to a magnetic nail set and marking the **place of beginning**;

Thence **South 86°44'21" East 582.61 feet**, following the centerline of County Highway 91, to a 3/4 inch iron bolt found at an angle point in the centerline of County Highway 91;

Thence **South 86°35'48" East 2566.30 feet**, following the centerline of the County Highway 91, to a magnetic nail set at the northwest corner of Earl and Darlene Freeman's 2.259 acre tract described in Official Record 5, page 589;

Thence **South 19°27'21" East 1632.42 feet**, following the east line of said 478.87 acre tract, the west line of said 2.259 acre tract, and the west line of Ronald E. Gonterman's 56.173 acre tract described in Official Record 857, page 306, passing at 21.70 feet an iron pin set, to an iron pin set in the south line of the McPherson Section and McArthur Township and north line of Section 25, Town 2, Range 15 and Harrison Township, and being on the Greenville Treaty Line and north line of Clifford and Joyce Baughman's 60.0 acre Tract V described in Deed Record 399, page 998;

Thence **South 83°14'05" West 3450.10 feet**, following the south line of the McPherson Section, said 478.87 acre tract, and McArthur Township, the north line of said Section 25, said 60.0 acre tract, and Harrison Township, and the Greenville Treaty Line, passing at 648.29 feet a 5/8 inch iron pin found at the northeast corner of Jake R. and Rosa Schwartz's 81.632 acre Tract I described in Official Record 798, page 150, to an iron pin set;

Thence **North 06°59'05" West 2147.06 feet**, entering the McPherson Section and McArthur Township, passing the west line of McArthur Township and entering Washington Township, passing at 2116.57 feet an iron pin set, to the **place of beginning, containing 139.449 acres**, more or less, and being subject to all valid easements and restrictions of record.

Of the above described 139.449 acre tract, 1.809 acres are within the right of way of County Highway 91. Also of the above described 139.449 acre tract, 134.429 acres are in McArthur Township and 5.020 acres are in Washington Township.

The above description was prepared based on an actual field survey made under the supervision of Paul R. Clapsaddle, Registered Surveyor #6140, during the month of June 2008. Iron pins set are 5/8 inch by 30 inch reinforcing rods with caps marked "CLAPSADDLE RS #6140." Bearings indicated herein are based on an assumed meridian and are to denote angles only.

ATTEST:

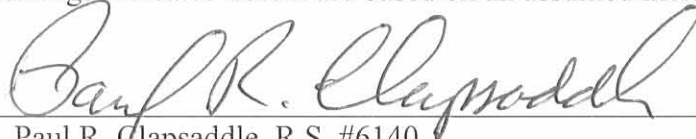
Paul R. Clapsaddle, R.S. #6140
19019 West Darby Road
Marysville, Ohio 43040
(937) 747-2599

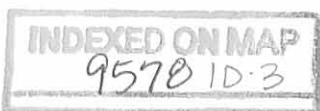

SURVEY FOR ELDEN ACRES

38.578 Acres

June 25, 2008

The following described 38.578 acre tract of land is situated in the State of Ohio, County of Logan, Townships of McArthur and Washington, part of McPherson Section, Town 7, Range 9 and Fractional Section 30, Town 7, Range 9, of the Congress Lands, and being part of Elden Acres, LLC's 478.87 acre Parcel One and all of their One Acre Parcel Two described in Official Record 885, page 556, and said 38.578 acre tract being more particularly described as follows:

Beginning at a $\frac{3}{4}$ inch iron bolt found at the intersection of the centerline of County Highway 91 (50 feet wide) with the centerline of Township Highway 33 (60 feet wide), said bolt being in the west line of the McPherson Section and said 478.87 acre tract and in the east line of Fractional Section 19, Town 7, Range 9, said bolt marking the **place of beginning**;

Thence **South 86°44'21" East (assumed bearing) 1077.39 feet**, following the centerline of County Highway 91, entering McPherson Section and said 478.87 acre tract, to a magnetic nail set;

Thence **South 06°59'05" East 2147.06 feet**, departing from the centerline of County Highway 91, passing at 30.49 feet an iron pin set and passing the east line of Washington Township and the west line of McArthur Township, to an iron pin set in the north line of Harrison Township, Section 25, Town 2, Range 15, north line of Jake R. and Rosa Schwartz's 81.632 acre Tract I described in Official Record 798, page 150, in the south line of the McPherson Section, McArthur Township and said 478.87 acre tract, and being on the Greenville Treaty Line;

Thence **South 83°14'05" West 208.21 feet**, following the south line of said 478.87 acre tract, McPherson Section and McArthur Township, the north line of said Section 25, Harrison Township, said 81.632 acre tract, and the Greenville Treaty Line, passing at 118.77 feet a 1 inch axle rod found at the southwest corner of McArthur Township and northwest corner of Harrison Township, thereafter entering Washington Township and following the north line of Jake R. and Rosa Schwartz's 0.573 acre Tract III described in Official Record 798, page 150, to an iron pin set at an angle point in the east line of Dayton Power and Light Company's 45.25 acre Parcel 9 described in Official Record 329, page 713 (deed overlap exist in said 45.25 acre tract and said 0.573 acre tract);

Thence **North 40°57'12" West 1272.17 feet**, following a southwest line of said 478.87 acre tract and said one acre tract, and following a northeast line of said 45.25 acre tract, departing from the McPherson Section and entering said Fractional Section 30, passing at 1247.43 feet an iron pin set, to a $\frac{5}{8}$ inch iron pin found in the centerline of Township Highway 33;

Thence **North 11°46'46" East 270.46 feet**, following the centerline of Township Highway 33 and a west line of said one acre tract, to a $\frac{5}{8}$ inch iron pin found at an angle point in the centerline of Township Highway 33;

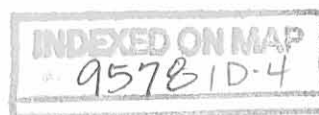

Thence **North 10°27'42" West 100.37 feet**, following a west line of said one acre tract, to a 5/8 inch iron pin found at an angle point in the centerline of Township Highway 33, in the southwest line of said 478.87 acre tract, southwest line the McPherson Section, and in the northeast line of said Fractional Section 30;

Thence **North 20°27'54" West 952.81 feet**, following the centerline of Township Highway 33, a southwest line of said 478.87 acre tract and the McPherson Section, and following the northeast line of Fractional Section 30 and Fractional Section 19, to the **place of beginning, containing 38.578 acres**, more or less, and being subject to all valid easements and restrictions of record.

Of the above described 38.578 acre tract, 1.518 acres are within the right of way of County Highway 91 and Township Highway 33. Of the above described 38.578 acre tract, 0.840 acres are in McArthur Township and 37.738 acres are in Washington Township. Also of the above described 38.578 acre tract, 1.187 acres are in Fractional Section 30 and includes all of said one acre tract and 37.391 are in the McPherson Section and is part of said 478.87 acre tract.

The above description was prepared based on an actual field survey made under the supervision of Paul R. Clapsaddle, Registered Surveyor #6140, during the month of June 2008. Iron pins set are 5/8 inch by 30 inch reinforcing rods with caps marked "CLAPSADDLE RS #6140." Bearings indicated herein are based on an assumed meridian and are to denote angles only.

ATTEST: Paul R. Clapsaddle
Paul R. Clapsaddle, R.S. #6140
19019 West Darby Road
Marysville, Ohio 43040
(937) 747-2599



REC'D 7-29-08 smj/ak

SURVEY FOR ELDEN ACRES
1.422 Acres
June 25, 2008

The following described 1.422 acre tract of land is situated in the State of Ohio, County of Logan, Township of Washington, part of the McPherson Section, Town 7, Range 9 of the Congress Lands, and being part of Elden Acres, LLC's 478.87 acre Parcel One described in Official Record 885, page 556, and said 1.422 acre tract being more particularly described as follows:

Beginning for reference at a 1 inch axle rod found at the southwest corner of McArthur Township, northwest corner of Harrison Township and Section 25, Town 2, Range 15, in the east line of Washington Township, at the northeast corner of Section 31, Town 2, Range 15, in the south line of the McPherson Section and said 478.87 acre tract (also being the Greenville Treaty Line), and at northeast corner of Jake R. and Rosa Schwartz's 0.573 acre Tract III described in Official Record 798, page 150;

Thence South 83°14'05" West (assumed bearing) 169.15 feet, following the south line of the McPherson Section, the north line of said Section 31, and following the Greenville Treaty Line, entering Washington Township, following north line of said 0.573 acre tract, and crossing the Dayton Power and Light Company's 45.25 acre Parcel 9 described in Official Record 329, page 713, to an iron pin set and marking the **place of beginning**;

Thence **South 83°14'05" West 236.93 feet**, following the south line of the McPherson Section and said 478.87 acre tract, the north line of said 0.573 acre tract and said Section 31, and following the Greenville Treaty Line, to an iron pin set at the southeast corner of Fractional Section 30, Town 7, Range 9 and Larry D. and Gay Denise Mitchell's 68.98 acre Tract I, Parcel One and Parcel Two described in Official Record 115, page 772;

Thence **North 19°30'24" West 536.03 feet**, following the west line of said 478.87 acre tract and the McPherson Section, the east line of said Fractional Section 30 and said 68.98 acre tract, to an iron pin set in the southwest line of said 45.25 acre tract;

Thence **South 40°57'12" East 632.04 feet**, following a southwest line of said 45.25 acre tract, to the **place of beginning, containing 1.422 acres**, more or less, and being subject to all valid easements and restrictions of record.

The above described 1.422 acre tract has no frontage on a public road and can only be transferred to an adjoining land owner with frontage on a public road.

The above description was prepared based on an actual field survey made under the supervision of Paul R. Clapsaddle, Registered Surveyor #6140, during the month of June 2008. Iron pins set are 5/8 inch by 30 inch reinforcing rods with caps marked "CLAPSADDLE RS #6140." Bearings indicated herein are based on an assumed meridian and are to denote angles only.

ATTEST:

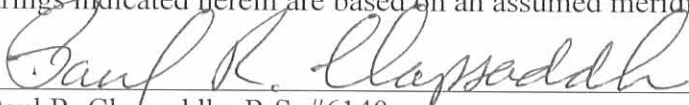

Paul R. Clapsaddle, R.S. #6140
19019 West Darby Road, Marysville, Ohio 43040
(937) 747-2599

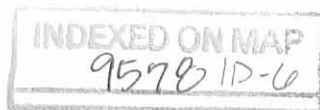

REC'D 7:29-08 SWY OK

**SURVEY FOR ELDEN ACRES
75 feet wide drainage easement
June 25, 2008**

The following described 75 feet wide drainage easement is situated in the State of Ohio, County of Logan, Townships of Washington and McArthur, McPherson Section, Town 7, Range 9 of the Congress Lands, and being over part of Elden Acres, LLC's 478.87 acre Parcel One described in Official Record 885, page 556, said drainage easement being more particularly described as follows:

Beginning for reference at a 3/4 inch iron bolt found at intersection of the centerline of County Highway 91 (50 feet wide) with the centerline of Township Highway 33 (60 feet wide), in the west line of the McPherson Section and in the west line of said 478.87 acre tract;

Thence **South 86°44'21" East (assumed bearing) 1077.39 feet**, following the centerline of County Highway 91, entering the McPherson Section and said 478.87 acre tract, to a magnetic nail set and marking the **place of beginning**;

Thence **South 86°44'21" East 582.61 feet**, following the centerline of County Highway 91, passing the east line of Washington Township and entering McArthur Township, to a 3/4 inch iron bolt found at an angle point in the centerline of County Highway 91;

Thence **South 86°35'48" East 1459.47 feet**, following the centerline of County Highway 91, to a point;

Thence **South 03°24'12" West 75.00 feet**, departing from the centerline of County Highway 91, to a point;

Thence **North 86°35'48" West 1459.37 feet**, to a point;

Thence **North 86°44'21" West 568.96 feet**, passing the west line of McArthur Township and entering Washington Township, to a point;

Thence **North 06°59'05" West 76.22 feet**, passing at 45.73 feet an iron pin set, to the **place of beginning**, and being subject to all valid easements and restrictions of record.

The above description was prepared based on an actual field survey made under the supervision of Paul R. Clapsaddle, Registered Surveyor #6140, during the month of June 2008. Iron pins set are 5/8 inch by 30 inch reinforcing rods with caps marked "CLAPSADDLE RS #6140." Bearings indicated herein are based on an assumed meridian and are to denote angles only.

ATTEST: Paul R. Clapsaddle
Paul R. Clapsaddle, R.S. #6140
19019 West Darby Road, Marysville, Ohio 43040
(937) 747-2599



SURVEYS FOR ELDEN ACRES

STATE OF OHIO, COUNTY OF LOGAN,
TOWNSHIPS OF MCARTHUR AND WASHINGTON,
MCPHERSON SECTION, TOWN 7, RANGE 9,
FRACTIONAL SECTION 30, TOWN 7,
RANGE 9, IN THE CONGRESS LANDS

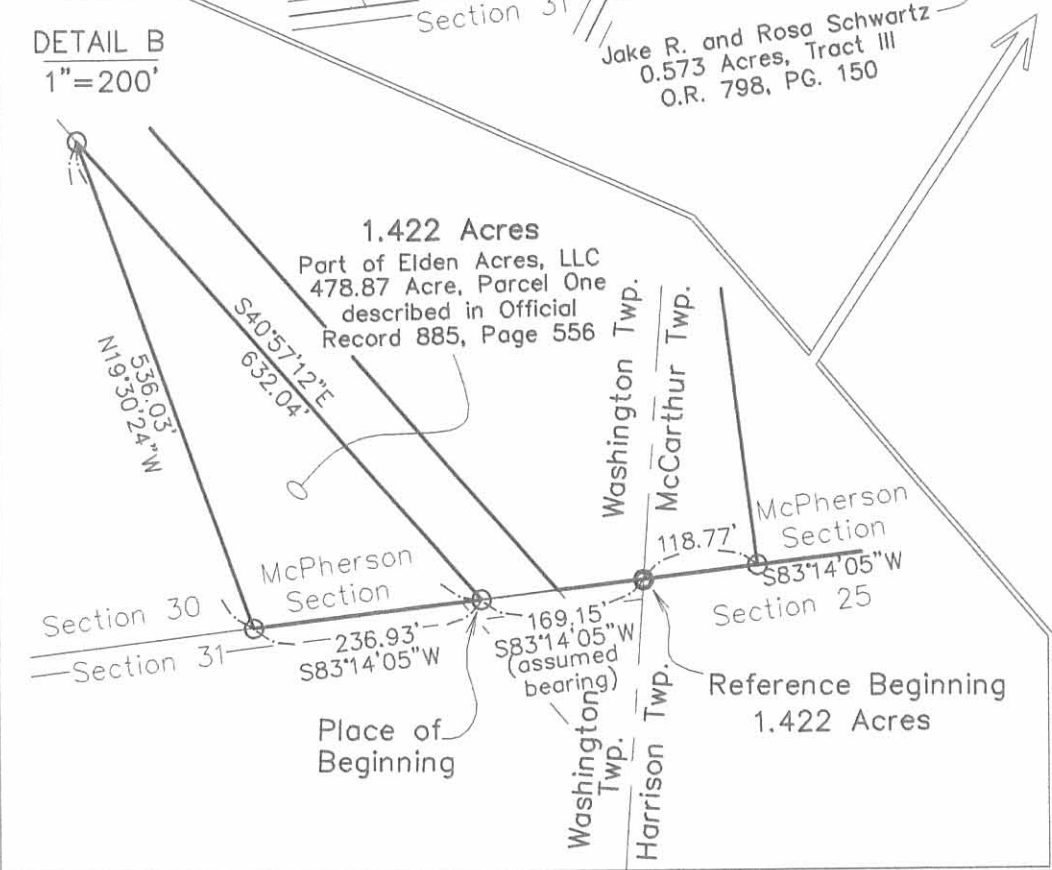
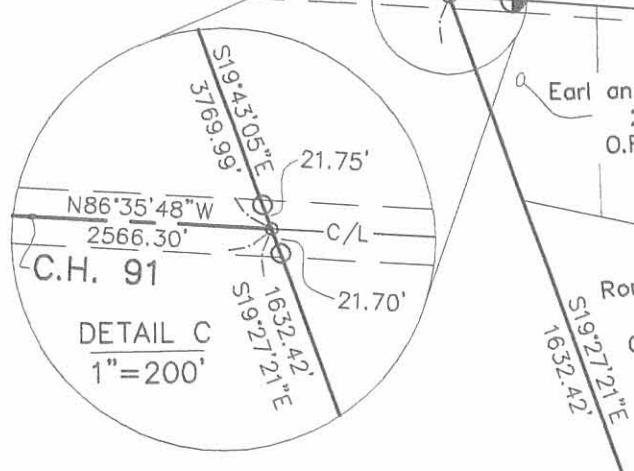
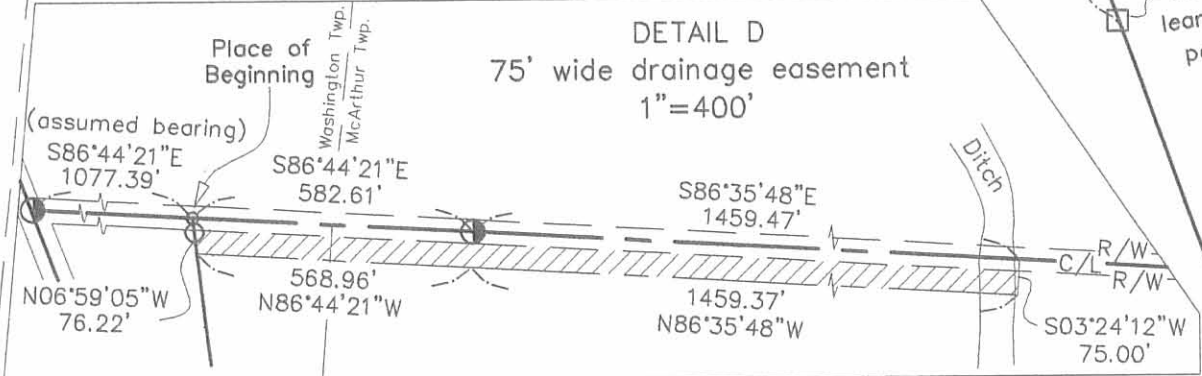
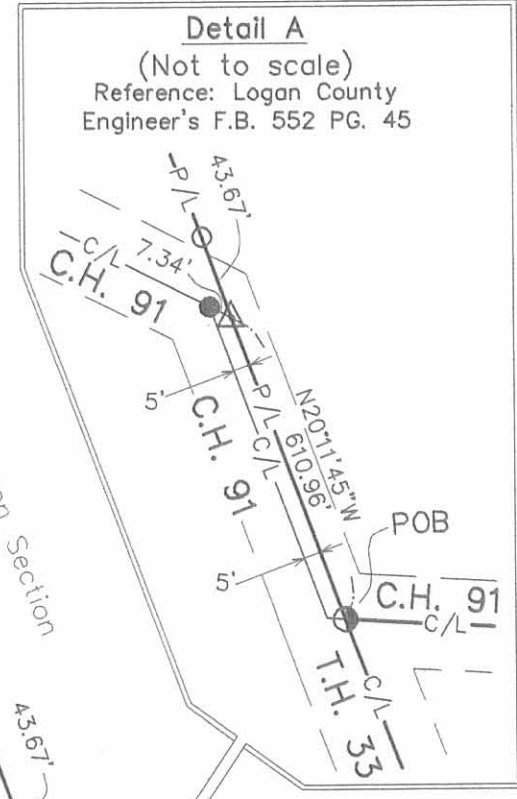
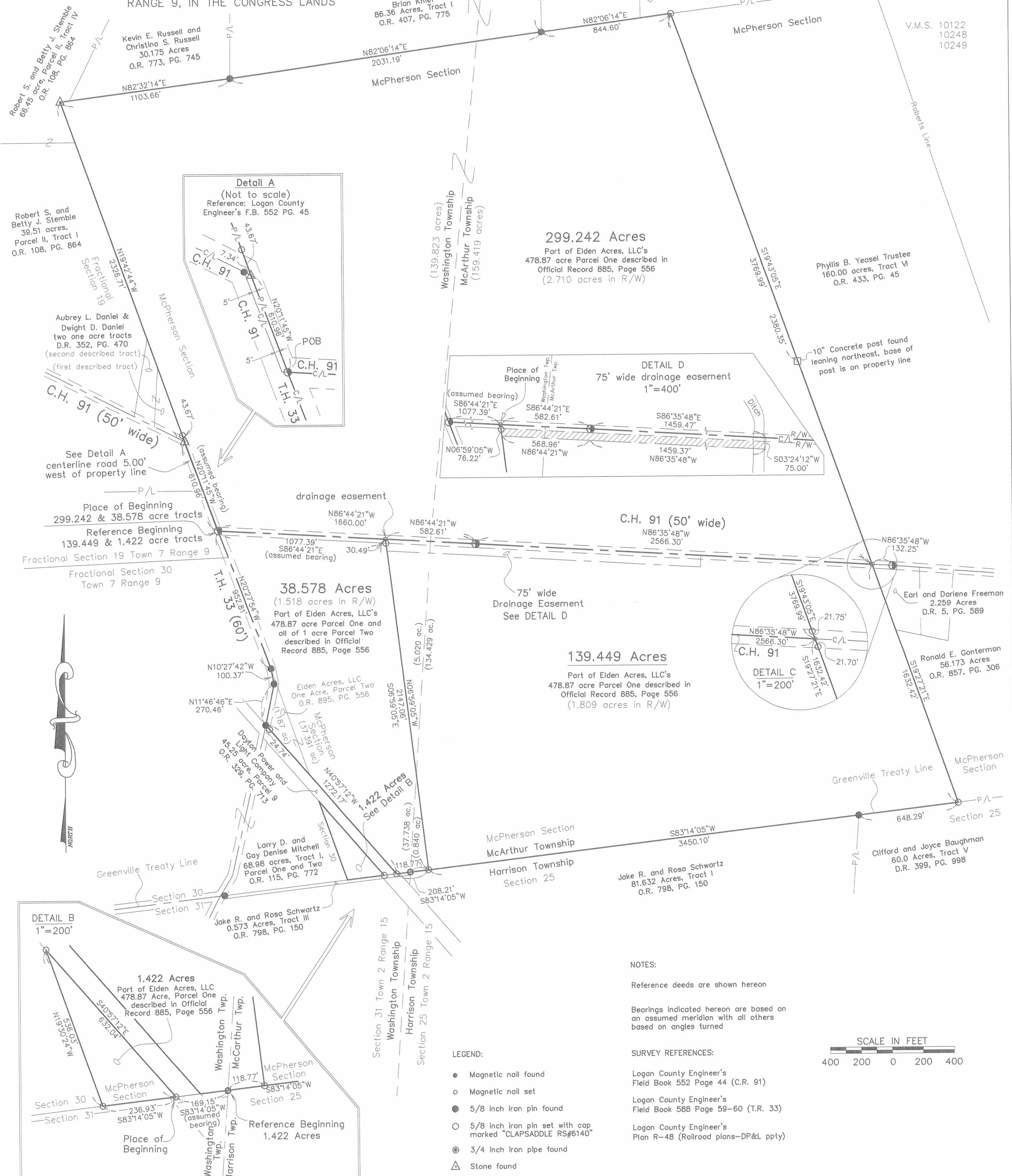

NOTES:
Reference deeds are shown hereon
Bearings indicated hereon are based on an assumed meridian with all others based on angles turned

- LEGEND:
- Magnetic nail found
 - Magnetic nail set
 - 5/8 inch iron pin found
 - 5/8 inch iron pin set with cap marked "CLAPSADDLE RS#6140"
 - ⊙ 3/4 inch iron pipe found
 - △ Stone found
 - 10" Concrete post found
 - 1 inch axle rod found
 - ⊕ 3/4 inch bolt found

SURVEY REFERENCES:
Logan County Engineer's Field Book 552 Page 44 (C.R. 91)
Logan County Engineer's Field Book 588 Page 59-60 (T.R. 33)
Logan County Engineer's Plan R-48 (Railroad plans-DP&L ppty)



I hereby certify that this plat was prepared from a field survey made under my supervision and that monuments were placed as indicated hereon.
Paul R. Clapsaddle
Paul R. Clapsaddle, R.S. #6140



Paul R. Clapsaddle and Associates
REGISTERED ENGINEERS AND SURVEYORS
19019 WEST DARBY ROAD, MARYSVILLE OHIO 43040
(937) 747-2599
Paul R. Clapsaddle, P.E., P.S.

Date: June 25, 2008
Scale: 1"=400'
Drawing: EldenAcresFormApril08.dwg
Project: EldenAcApr08

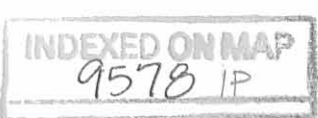

RECID 4-8-09 SMOYOK

Lee Surveying and Mapping Co., Inc.

Land Surveys • Topography • Subdivisions • Construction Layout

117 N. Madriver St.
Bellefontaine OH 43311

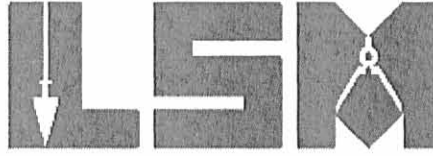

Phone: (937) 593-7335
Fax: (937) 593-7444

MILLER 16.500 ACRES

Lying in Fractional Section 30, Town 7, Range 9 and McPherson Section, Town 7, Range 9, Washington and McArthur Township, Logan County, Ohio.

Being out of the Harvey D. Miller and Emma G. Miller 38.578 acre tract as deeded and described in Official Record 927, Page 001 of the Logan County Records of Deeds and being more particularly described as follows:

Commencing on a 1 inch iron bar found on the east line of Fractional Section 19 on the intersection of the center-lines of County Highway 91 and Township Road 33.

THENCE, with the center-line of Township Road 33 (60 feet wide), the following two courses:

S 20°-42'-15"E, a distance of 952.79 feet to a 1 inch square iron bar found.

S 10°-56'-53"E, a distance of 49.93 feet to a MAG nail set at the TRUE POINT OF BEGINNING.

THENCE, S 75°-04'-54"E, a distance of 901.59 feet to a 5/8 inch iron rod set, passing a 5/8 inch iron rod set at 33.34 feet.

THENCE, with the west line of the Michael J. Rethman 139.449 acre tract (O.R. 926, Pg. 991), S 07°-14'-23"E, a distance of 1022.45 feet to a 5/8 inch iron rod found on the south line of the McPherson Section and McArthur Township and the north line of Section 25 and Harrison Township and on the Greenville Treaty Line.

THENCE, with the south line of the McPherson Section and McArthur Township and the north line of Section 25 and Harrison Township, along the Greenville Treaty Line and the north line of the Jake R. Schwartz 81.632 acre tract (O.R. 798, Pg. 150, Tract I), S 82°-58'-20"W, a distance of 118.80 feet to a 1 inch axle found on the southwest corner of McArthur Township, the northwest corner of Section 25 and Harrison Township, northeast corner of Section 31 and the east line of Washington Township.

THENCE, with the south line of the McPherson Section and the north line of Section 31, along the Greenville Treaty Line and the north line of the Jake R. Schwartz 0.573 acre tract (O.R. 798, Pg. 150, Tract III), S 82°-58'-20"W, a distance of 89.33 feet to a 5/8 inch iron rod found.

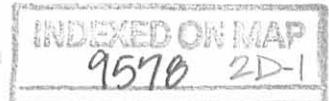

Lee Surveying and Mapping Co., Inc.

Land Surveys • Topography • Subdivisions • Construction Layout

117 N. Madriver St.
Bellefontaine OH 43311

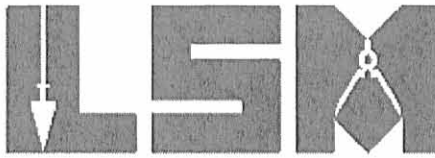

Phone: (937) 593-7335
Fax: (937) 593-7444

THENCE, with the easterly line of the Dayton Power and Light Company 42.250 acre tract (O.R. 329, Pg. 713, Parcel 9), N 41°-11'-15"W, a distance of 1272.64 feet to a railroad spike found on the center-line of Township Road 33, passing a 5/8 inch iron rod set at 1234.93 feet.

THENCE, with the center-line of Township Road 33, the following two courses:

N 11°-31'-29"E, a distance of 270.58 feet to a 5/8 inch iron rod found.

N 10°-56'-53"W, a distance of 49.92 feet to the point of beginning.

Containing 16.500 acres, of which 0.228 acre is within the highway right-of-way. There are 1.187 acres within Fractional Section 30 and 15.313 acres within the McPherson Section. There are 15.660 acres within Washington Township and 0.840 acre within McArthur Township.

The basis for bearings is the center-line of Township Road 33, being N 11°-31'-29"E, and all other bearings are from angles and distances measured in a field survey by Lee Surveying and Mapping Co., Inc. on March 31, 2009.



ORIGINAL STAMP IN GREEN

Description prepared by:

A handwritten signature in black ink that reads 'William K. Bruce'.

William K. Bruce
Professional Surveyor 7437
April 1, 2009
Revised April 8, 2009

4767039

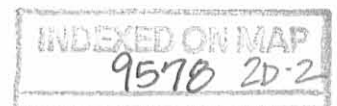

REC'D 4-8-09 smj/ck

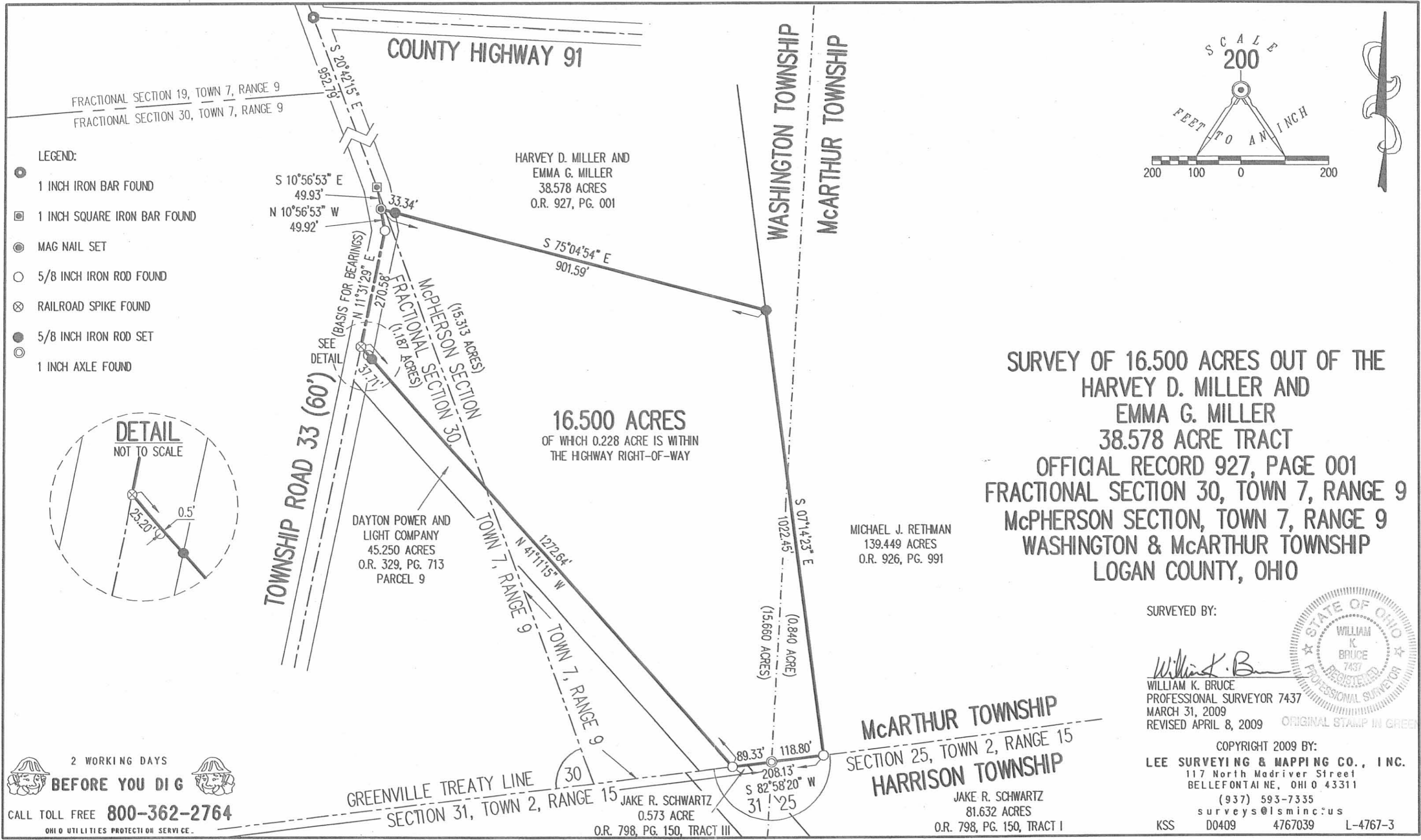

FRACTIONAL SECTION 19, TOWN 7, RANGE 9
 FRACTIONAL SECTION 30, TOWN 7, RANGE 9

- LEGEND:**
- 1 INCH IRON BAR FOUND
 - 1 INCH SQUARE IRON BAR FOUND
 - ⊙ MAG NAIL SET
 - 5/8 INCH IRON ROD FOUND
 - ⊗ RAILROAD SPIKE FOUND
 - 5/8 INCH IRON ROD SET
 - ⊙ 1 INCH AXLE FOUND

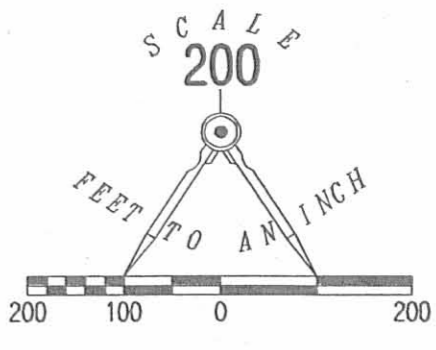
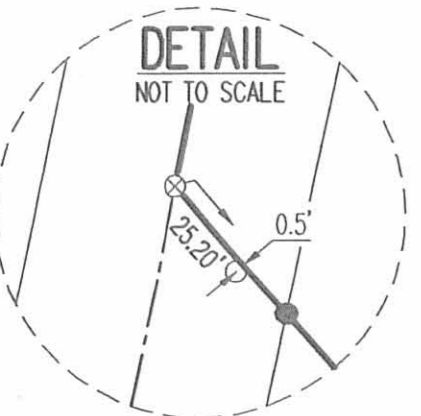

SURVEY OF 16.500 ACRES OUT OF THE HARVEY D. MILLER AND EMMA G. MILLER 38.578 ACRE TRACT OFFICIAL RECORD 927, PAGE 001 FRACTIONAL SECTION 30, TOWN 7, RANGE 9 McPHERSON SECTION, TOWN 7, RANGE 9 WASHINGTON & McARTHUR TOWNSHIP LOGAN COUNTY, OHIO

SURVEYED BY:
William K. Bruce
 WILLIAM K. BRUCE
 PROFESSIONAL SURVEYOR 7437
 MARCH 31, 2009
 REVISED APRIL 8, 2009 ORIGINAL STAMP IN GREEN



2 WORKING DAYS BEFORE YOU DIG
 CALL TOLL FREE 800-362-2764
 OHIO UTILITIES PROTECTION SERVICE

INDEXED ON MAP
 9578 2P

REV'D 10-14-10 SUM OR

Lee Surveying and Mapping Co., Inc.

Land Surveys • Topography • Subdivisions • Construction Layout

117 N. Madriver St.
Bellefontaine OH 43311



Phone: (937) 593-7335
Fax: (937) 593-7444
surveys@lsminc.us

MILLER 22.073 ACRES

Lying in Fractional Section 30, Town 7, Range 9 and McPherson Section, Town 7, Range 9, Washington Township, Logan County, Ohio.

Being all of the remainder of the Harvey D. Miller and Emma G. Miller original 38.578 acre tract as deeded and described in Official Record 927, Page 001 and Official Record 950, Page 922 of the Logan County Records of Deeds and being more particularly described as follows:

Beginning on a 1 inch iron bar found on the west line of the McPherson Section on the intersection of the center-lines of County Highway 91 and Township Road 33.

THENCE, with the center-line of County Highway 91 (50 feet wide), S 86°-59'-03"E, a distance of 1077.29 feet to a MAG nail found.

THENCE, with the west line of the Michael J. Rethman 139.449 acre tract (O.R. 926, Pg. 991), S 07°-14'-23"E, a distance of 1124.67 feet to a 5/8 inch iron rod found, passing a 5/8 inch iron rod found at 30.50 feet.

THENCE, with the north line of the Brad M. Harshbarger 16.500 acre tract (O.R. 949, Pg. 278), N 75°-04'-54"W, a distance of 901.59 feet to a MAG nail found on the center-line of Township Road 33, passing a 5/8 inch iron rod found at 868.25 feet.

THENCE, with the center-line of Township Road 33 (60 feet wide), the following two courses:

N 10°-56'-53"W, a distance of 49.93 feet to a 1 inch square iron bar found.

N 20°-42'-15"W, a distance of 952.79 feet to the point of beginning.

Containing 22.073 acres, of which 1.290 acres are within the highway rights-of-way. There are 22.068 acres in the McPherson Section and 0.005 acre in Fractional Section 30.

Property is subject to any and all previous easements and rights-of-way of record.

The basis for bearings is the west line of the McPherson Section, being N 20°-42'-15"W, and all other bearings are from angles and distances measured in a field survey by Lee Surveying and Mapping Co., Inc. on October 6, 2010.



ORIGINAL STAMP IN GREEN

Description prepared by:

A handwritten signature in black ink that reads 'William K. Bruce'.

William K. Bruce
Professional Surveyor 7437
October 7, 2010

47671010

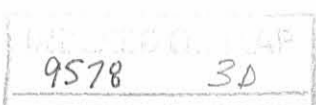

REC'D 10-14-10 *SMC*

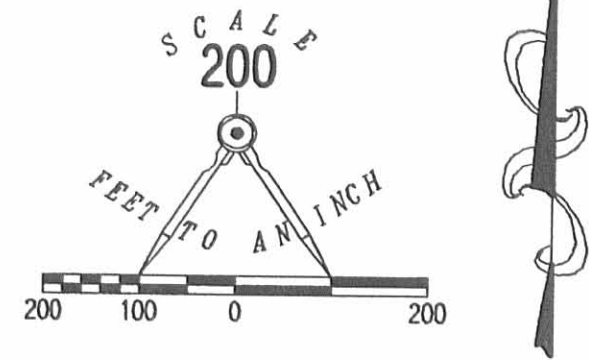
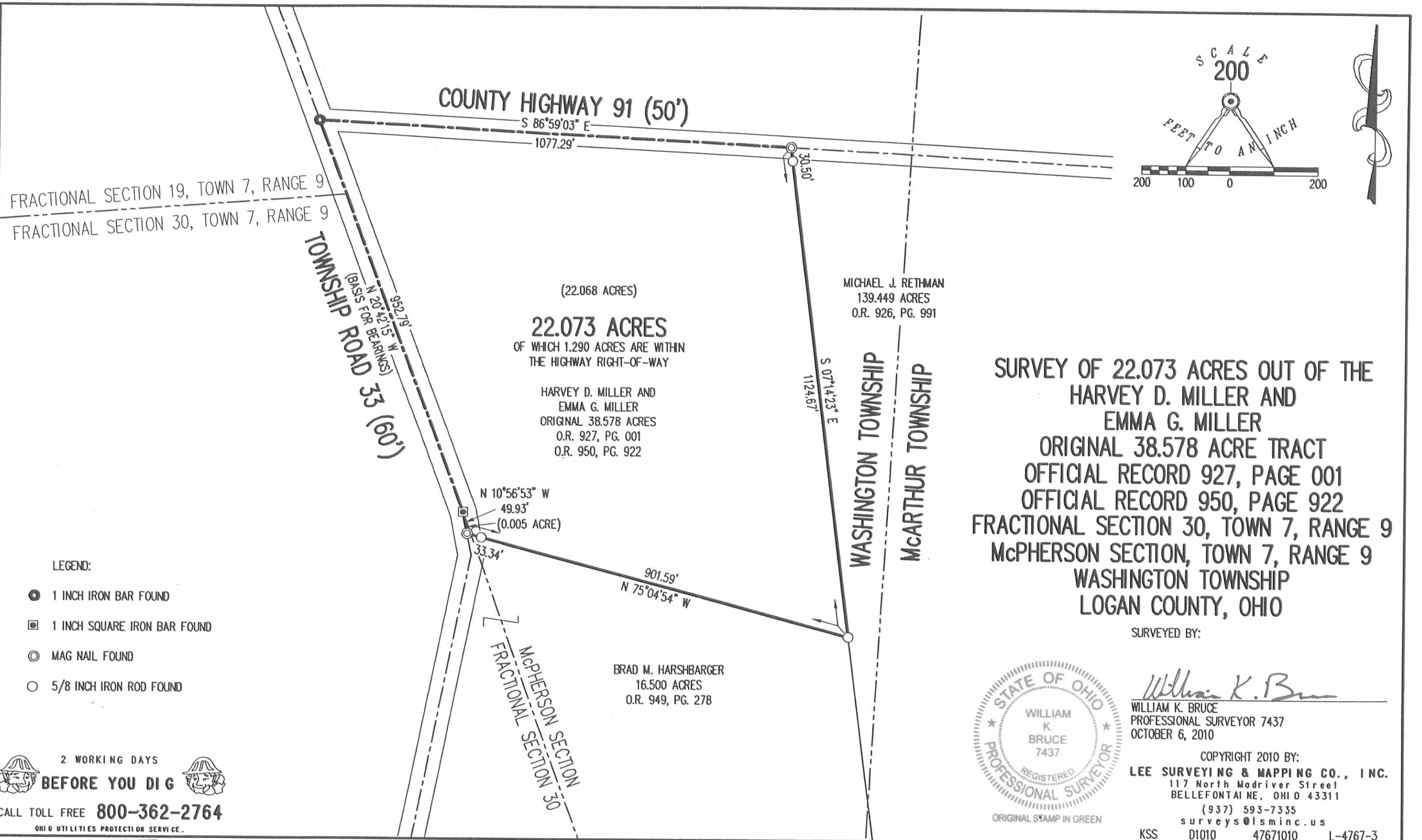

SURVEY OF 22.073 ACRES OUT OF THE HARVEY D. MILLER AND EMMA G. MILLER ORIGINAL 38.578 ACRE TRACT OFFICIAL RECORD 927, PAGE 001 OFFICIAL RECORD 950, PAGE 922 FRACTIONAL SECTION 30, TOWN 7, RANGE 9 McPHERSON SECTION, TOWN 7, RANGE 9 WASHINGTON TOWNSHIP LOGAN COUNTY, OHIO

SURVEYED BY:

William K. Bruce
WILLIAM K. BRUCE
PROFESSIONAL SURVEYOR 7437
OCTOBER 6, 2010



COPYRIGHT 2010 BY:
LEE SURVEYING & MAPPING CO., INC.
117 North Modriver Street
BELLEFONTAINE, OHIO 43311
(937) 593-7335
surveys@lsmcinc.us
KSS D1010 47671010 L-4767-3

2 WORKING DAYS
BEFORE YOU DIG
CALL TOLL FREE **800-362-2764**
OHIO UTILITIES PROTECTION SERVICE.

INDEXED ON MAP
9578 3P

1-5-2021

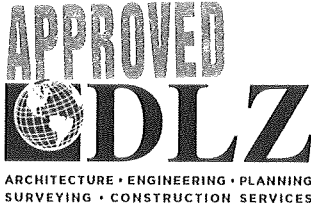

INNOVATIVE IDEAS
EXCEPTIONAL DESIGN
UNMATCHED CLIENT SERVICE

MATHYS AND LAMB

7.395 ACRES

Lying in the McPherson Section, Town 7, Range 9, Washington Township, Logan County, Ohio (all records referenced herein refer to the Logan County Records of Deeds).

Being out of the Kenneth Zane Mathys and Catherine A. Mathys (1/2 interest) and Christopher Clay Lamb and McKenzie Lee Lamb (1/2 interest), 22.073 acres as deeded and described in Official Record 1008, Page 585 and being more particularly described as follows:

COMMENCING at a railroad spike found at the intersection of the center-lines of County Highway 91 (50 feet wide) and Township Road 33 (60 feet wide);

THENCE, with said center-line of County Highway 91, S 86°-04'-55" E, a distance of 777.32 feet to a MAG nail set at the **TRUE POINT OF BEGINNING**;

THENCE, continuing with said center-line, S 86°-04'-55" E, a distance of **300.00 feet** to a MAG nail found at the northerly corner common to said 22.073 acre tract and the Michael J. Rethman and Maria A. Rethman 139.449 acre tract as deeded and described in Official Record 926, Page 991;

THENCE, with the line common to said 22.073 acre and 139.449 acre tracts, S 06°-20'14" E, passing a 5/8 inch iron rebar found at a distance of 30.52 feet, a total distance of **1124.61 feet** to a 5/8 inch iron rebar found on the westerly line of said 139.449 acre tract, at a corner common to said 22.073 acre tract and the Kim W. Comer and Nancy L. Comer 16.500 acre tract as deeded and described in Official Record 1227, Page 963;

THENCE, with the line common to said 22.073 acre and 16.500 acre tracts, N 74°-11'-13" W, a distance of **318.73 feet** to an iron rebar set;

THENCE, with a division line through said 22.073 acre tract, N 06°-20'-14" W, passing an iron rebar set at a distance of 1032.44 feet, a total distance of **1057.85 feet** to the **POINT OF BEGINNING**.

INDEXED ON MAP
9570



INNOVATIVE IDEAS
EXCEPTIONAL DESIGN
UNMATCHED CLIENT SERVICE

Containing **7.395 acres**, more or less, of which 0.172 acre is within the highway right-of-way.

Iron rebar set, where indicated, are 30 inches in length, 5/8 inch in diameter with a plastic I.D. cap stamped "DLZ OHIO INC."

Property is subject to any and all previous easements and rights-of-way of record.

Bearings and distances, described herein, are derived from GPS observations based on Grid North, Ohio State Plane Coordinate System, North Zone, NAD83 (2011, Epoch 2010), with the center-line of County Highway 91, having a bearing of S 86°-04'-55" E. Distances are expressed in U.S. Survey Feet. All other measurements are from angles and distances measured in a field survey by DLZ Ohio, Inc. on December 23, 2020.

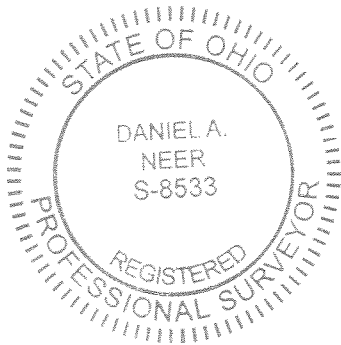

Description prepared by:

Daniel A. Neer

Professional Surveyor No. 8533

December 28, 2020

2021-2169.00



1-5-2021



APPROVED

ACCESS MANAGEMENT NOTE:

COUNTY HIGHWAY 91 IS CLASSIFIED AS A LOCAL ROAD.
MINIMUM DRIVE SPACING IS 250'
MINIMUM STOPPING SIGHT DISTANCE IS >495 (55 MPH)
NO ADDITIONAL DRIVES REQUESTED.

DEED & SURVEY REFERENCES:

REFERENCE DEEDS ARE SHOWN HEREON

LOGAN COUNTY ENGINEER'S MAP ROOM
FILES: 9578 AND 1295

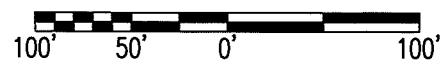
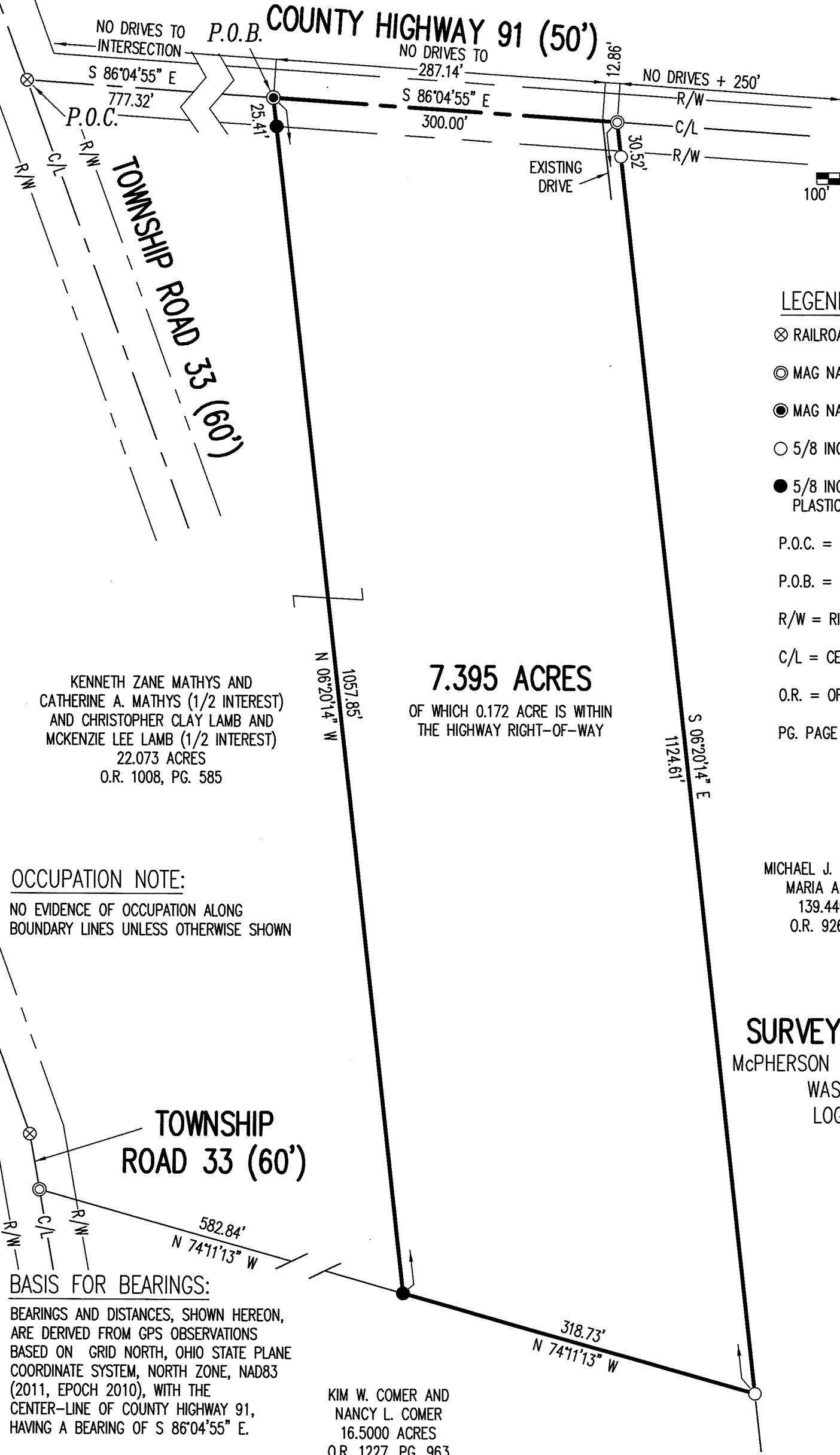

SCALE: 1" = 100'
DISTANCES SHOWN HEREON
ARE IN U.S. SURVEY FEET

LEGEND:

- ⊗ RAILROAD SPIKE FOUND
- ⊙ MAG NAIL FOUND
- MAG NAIL SET
- 5/8 INCH IRON REBAR FOUND
- 5/8 INCH BY 30 INCH IRON REBAR SET WITH PLASTIC I.D. CAP STAMPED "DLZ OHIO INC."
- P.O.C. = POINT OF COMMENCEMENT
- P.O.B. = POINT OF BEGINNING
- R/W = RIGHT-OF-WAY
- C/L = CENTER-LINE
- O.R. = OFFICIAL RECORD
- PG. PAGE

KENNETH ZANE MATHYS AND
CATHERINE A. MATHYS (1/2 INTEREST)
AND CHRISTOPHER CLAY LAMB AND
MCKENZIE LEE LAMB (1/2 INTEREST)
22.073 ACRES
O.R. 1008, PG. 585

7.395 ACRES
OF WHICH 0.172 ACRE IS WITHIN
THE HIGHWAY RIGHT-OF-WAY

MICHAEL J. RETHMAN AND
MARIA A. RETHMAN
139.449 ACRES
O.R. 926, PG. 991

SURVEY OF 7.395 ACRES
McPHERSON SECTION, TOWN 7, RANGE 9
WASHINGTON TOWNSHIP
LOGAN COUNTY, OHIO

OCCUPATION NOTE:

NO EVIDENCE OF OCCUPATION ALONG
BOUNDARY LINES UNLESS OTHERWISE SHOWN

**TOWNSHIP
ROAD 33 (60')**

BASIS FOR BEARINGS:

BEARINGS AND DISTANCES, SHOWN HEREON,
ARE DERIVED FROM GPS OBSERVATIONS
BASED ON GRID NORTH, OHIO STATE PLANE
COORDINATE SYSTEM, NORTH ZONE, NAD83
(2011, EPOCH 2010), WITH THE
CENTER-LINE OF COUNTY HIGHWAY 91,
HAVING A BEARING OF S 86°04'55" E.

KIM W. COMER AND
NANCY L. COMER
16.5000 ACRES
O.R. 1227, PG. 963

THIS SURVEY WAS PREPARED IN THE
ABSENCE OF A COMPLETE AND ACCURATE
TITLE SEARCH AND DOES NOT GUARANTEE
TITLE.

COPYRIGHT 2020 BY:



117 N. Madriver Street • Bellefontaine, OH 43311
(937) 593-7335 • www.dlz.com
Project #2021-2169.00

DANIEL A. NEER
PROFESSIONAL SURVEYOR NO. 8533
DECEMBER 23, 2020

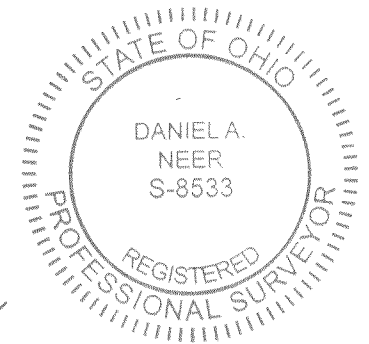

DRAWN BY:	DESCRIPTION	REV. NO.	DATE
KSS			12/28/2020

INDEXED ON MAP
9578