

BRACKNEY SURVEY
V.M.S. 5045
LAKE TOWNSHIP
January 22, 1972

The following described real estate situated in Lake Township,
Logan County, Ohio and being part of Virginia Military Survey 5045
and more particularly described as follows:

Beginning at a railroad spike in the center of County Highway
No.1 at Station 317 + 78.7 as shown in Logan County Engineers
field book 598, page 26; thence with the centerline of said road
N.19° 30'W. 130.0 feet to a railroad spike, passing the southeast
corner of Jack E. Hufford's 2.69 acre tract at 38.3 feet; thence
East 190.0 feet to an iron bar, passing an iron bar at 31.82 feet;
thence S.19° 30'E. 130.0 feet to an iron bar; thence West 190.0
feet to the place of beginning, passing an iron bar at 158.18 feet.

Containing 0.53 of an acre more or less.

The above described tract being part of Mary E. Brackney's 54.27
acre tract.

4933 1D

INDEXED ON MAP

MARY E. BRACKNEY
53.74 AC.

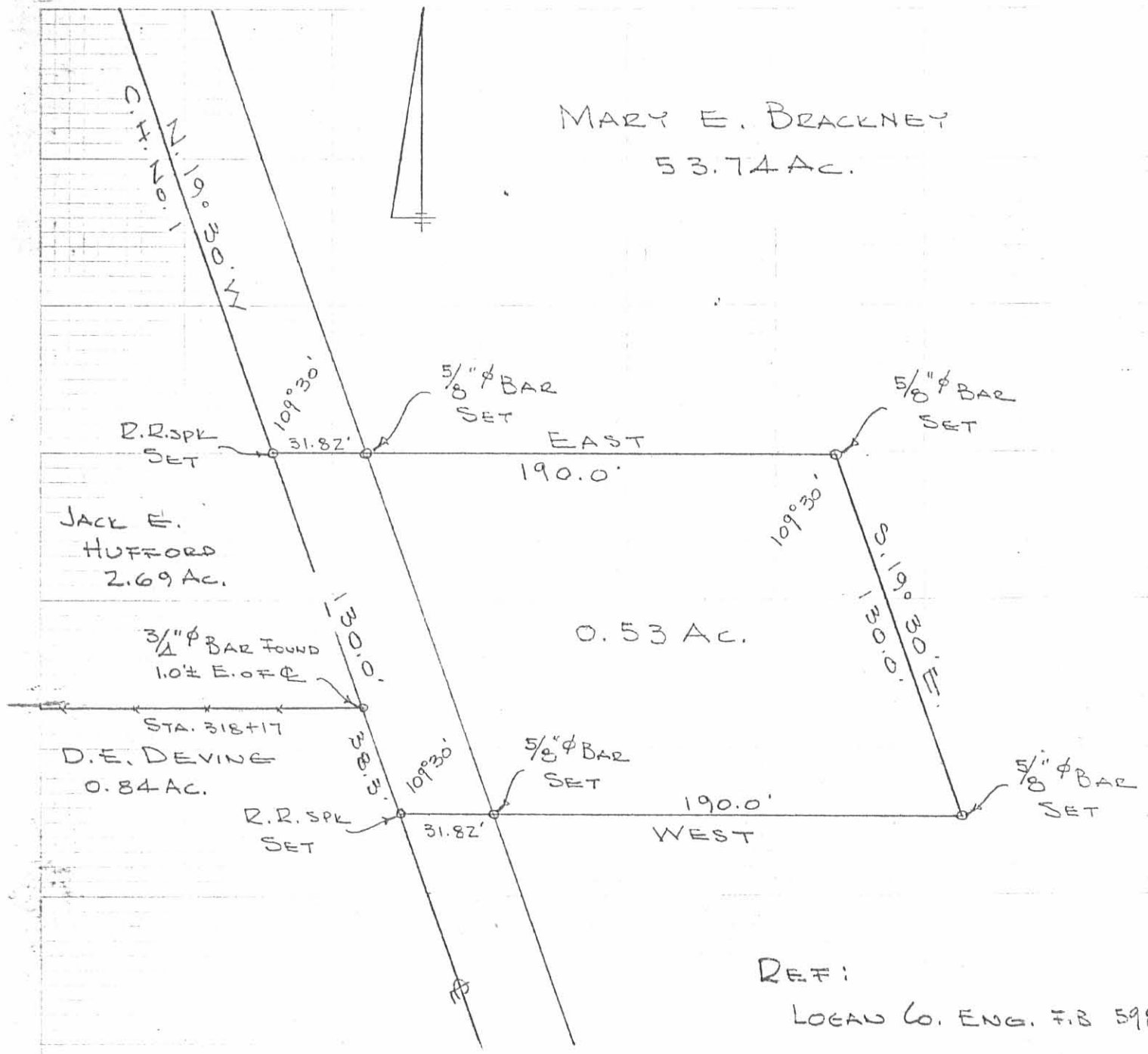

REF:
LOGAN CO. ENG. F.B 598 PG. 26

BRACKNEY SURVEY
V.M.S. 5045
LAKE TOWNSHIP
LOGAN COUNTY, OHIO
JANUARY 22, 1972
SCALE 1" = 50'

4933 IP

INDEXED ON MAP

DAN L. DODSON
REG. SURVEYOR 4270
BELLEFONTAINE, O.
BL 18/56

DESCRIPTION OF SHAWVER LAND FOR CHALFANT & INSKEEP

North Tract

The following described land situated in Lake Township, Logan County Ohio, being in Virginia Military Surveys 9572 & 5045, and bounded and described as follows:

Beginning at a stone in the East line of Survey 9572 at the south east corner of James B. Hemphills 12.00 acre tract, in Survey 9572;

Thence with the west line of Survey 4498 and with the west line of James B. Hemphills 77.04 acre tract, S. $3^{\circ} 56'$ W. 26.74 chains to a stake in the center of a public road and southwest corner of said Hemphill land;

Thence with the center line of said road N. $85 \frac{1}{4}^{\circ}$ W. 15.98 chains to an iron pin in the north line of the right of way of the Toledo and Ohio Central Railway; Thence with the north line of said right of way N. ~~$56 \frac{1}{2}$~~ ^{$53 \frac{1}{2}$} W. 4.07 chains to an iron fence post in the east line of the R.L. Park land and in the Ludlow line;

Thence with the Ludlow line N. $14 \frac{3}{4}^{\circ}$ W. 25.55 chains to a stake at the southwest corner of D.E. Shawvers land in Survey 9572;

Thence with said Shawvers south line S. $86 \frac{3}{4}^{\circ}$ E. 15.30 chains to a stone at the southwest corner of James B. Hemphills 12.00 acre tract;

Thence with the south line of said 12.00 tract S. $86 \frac{1}{2}^{\circ}$ E. 12.00 chains to the place of beginning, containing 60.77 acres, of which $6 \frac{1}{2}$ acres are in Survey 9572 and 54.27 acres are in Survey 5045.

INDEXED ON MAP
49332D

DESCRIPTION OF SHAWVER LAND, IN LAKE TOWNSHIP.

(For Chalfant, Inskeep et al.)

South Tract.

The following described land situated in Lake Township, Logan County, Ohio, being part of Virginia Military Survey 5045 and bounded and described as follows:- Beginning at a stake in the east line of said Survey 5045 at a point 20 feet north of a stone at the northeast corner of the 6.48 acre tract belonging to Patrick Fitzpatrick in said Survey 5045;

Thence with the Survey line and west line of the Cyrus E, Wallace 69.12 acre tract in Survey 4498, N 3° 15' E 31.04 chains to a stake at said Wallaces N.W. corner ~~in the center line of~~ in the center line of a public road;

Thence with the center line of said road N. 85 1/4° W. ~~#####~~ 18.86 chains to a stake in the Ludlow Line;

Thence with the Ludlow Line S. 14 3/4° E. 32.68 chains to a stake in the north line of a ~~#####~~ strip 30 feet wide belonging to Patrick Fitzpatrick;

Thence with the northline of said strip S. 85° 10' E. 8.76 chains to the place of beginning containing 42.92 acres, excepting therefrom the land of the Toledo and Ohio Central Railway Company, the same being a strip 1.00 chain wide and 20.68 chains long containing 2.07 acres, leaving a net acreage of 40.85.

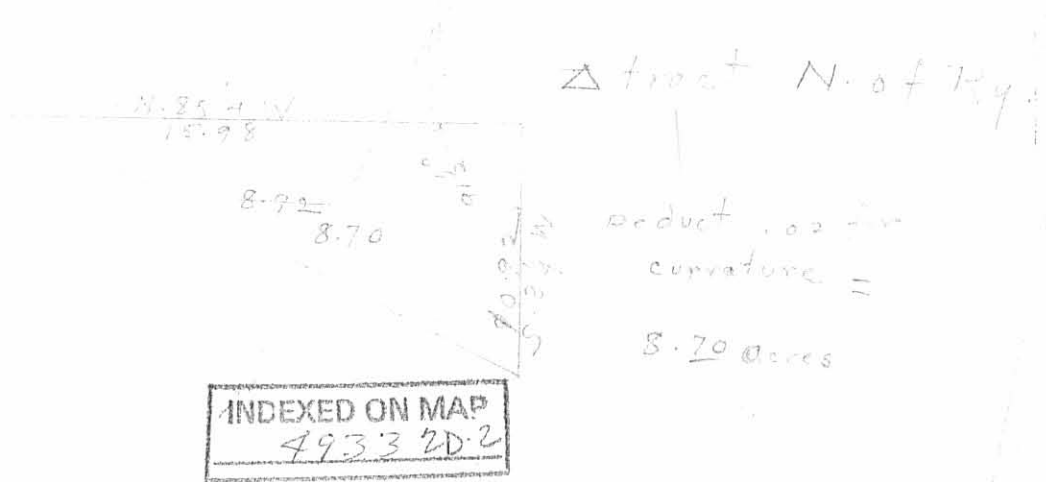

Received 6.30.89 OK C.R.

Lee Surveying and Mapping Co.



Farm Surveys • Lot Surveys • Topography • Subdivisions • Construction Layout

855 EAST SANDUSKY AVENUE
BELLEFONTAINE, OHIO 43311

(513) 593-5780

CLAYTON M. LEE, P.S.
JEFFREY I. LEE, P.S.

BRACKNEY - SHEELY (0.157 ACRE)

Lying in V.M.S. 5045, Lake Township, Logan County, Ohio.

Being out of that original 53.7 acre tract in the name of Brackney as deeded and described in Volume 406, Page 36-38 of the Logan County Records of Deeds and being an addition, on the east side, to the Sandra Sheely 0.53 acre tract (Volume 377, Page 267) and being more particularly described as follows:

Beginning at a 5/8" iron rod found on the south line of the E.H. Godwin 1.116 acre tract (Volume 42, Page 994) marking the northeast corner of the said 0.53 acre.

THENCE, with the Godwin south line, S 89°-00' E, a distance of 55.77 feet to a 1/2" iron rod found on the southeast corner of said 1.116 acre tract.

THENCE, with the east line of said 1.116 acre tract, extended southerly, S 18°-30' E, a distance of 130.00 feet to a 5/8" iron rod (set).

THENCE, with the south line, extended, of the said Sheely 0.53 acre tract, N 89°-00' W, a distance of 55.77 feet to a 5/8" iron rod found at the southeast corner of the said Sheely 0.53 acre tract.

THENCE, with the east line of said 0.53 acre tract, N 18°-30" W, a distance of 130.00 feet to the point of beginning.

Containing 0.157 acre.

This description prepared from an actual field survey.
Basis for bearings: Center-line of Ludlow Road = N 18°-30' W.

Prepared by:

Clayton M. Lee
Registered Professional Surveyor No. 6181
June 28, 1989



ORIGINAL STAMP IN GREEN

INDEXED ON MAP
4933 3D

L-1529

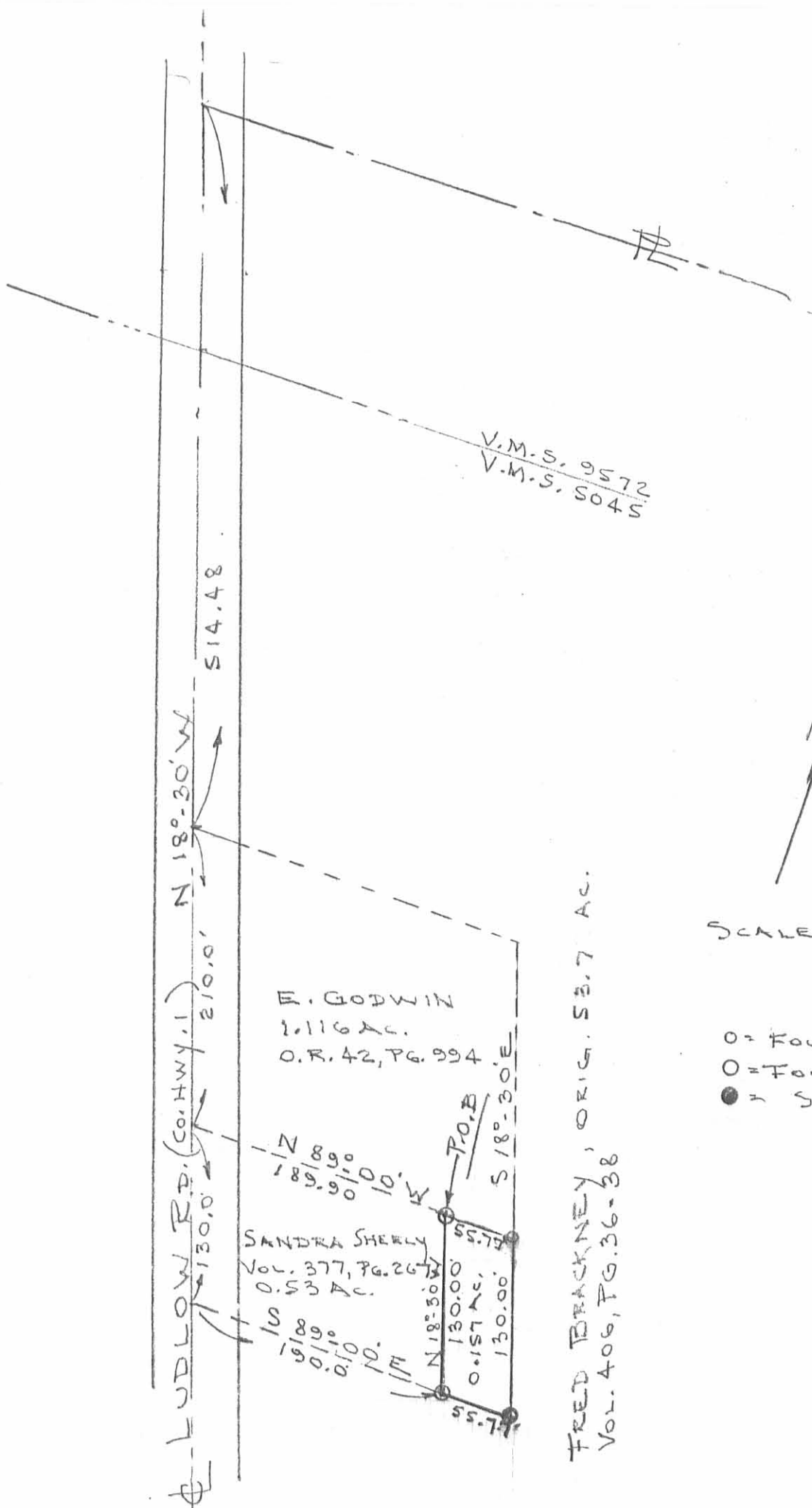

SCALE = 1" = 100'

- = FOUND 1/2" IRON ROD
- = FOUND 3/8" IRON ROD
- = SET " " "

SURVEY OF 0.157 ACRE ADDITION TO THE
 SANDRA SHEELY 0.53 ACRE LOT
 (VOL. 377, PG. 267)
 V.M.S. 5045, LAKE TWP.
 LOGAN COUNTY, OHIO

INDEXED ON MAP
 49333P

By: *[Signature]*
 JEFFREY I. LEE
 REG. SURVEYOR 6359
 JUNE 14, 1989



ORIGINAL STAMP IN GREEN

Lee Surveying and Mapping Co.



Farm Surveys • Lot Surveys • Topography • Subdivisions • Construction Layout

855 EAST SANDUSKY AVENUE
BELLEFONTAINE, OHIO 43311

(513) 593-5780

CLAYTON M. LEE, P.S.
JEFFREY I. LEE, P.S.

BRACKNEY SURVEY

Lying in V.M.S. 5045, Lake Township, Logan County, Ohio.

Being off the west side of that 54.27 acres in the name of Brackney as deeded and described in Volume 406, Page 36 to 38 and being more particularly described as follows:

Beginning at a railroad spike found on the center-line of County Road 1 (Ludlow Road) a distance of 514.48 feet, southerly along said center-line, from the northwest corner of grantor's said 54.27 acre tract.

THENCE, S 89°-30' E, a distance of 245.69 feet to a 1/2" iron rod, passing an iron rod at 31.83 feet.

THENCE, parallel to County Road 1, S 18°-30" E, a distance of 210.00 feet to a 1/2" iron rod.

THENCE, with the north line and the north line extended of the Sheeley 0.53 acre lot (Volume 377, Page 267), N 89°-30" W, a distance of 245.69 feet to a railroad spike found on the center-line of Ludlow Road, passing a 1/2" iron rod at 213.86 feet.

THENCE, with the said road center-line, N 18°-30' W, a distance of 210.00 feet to the point of beginning.

Containing 1.116 acres.

Basis for bearings=Center-line Ludlow Road (N 18°-30' W).
This description prepared from an actual field survey.

Prepared by:

Clayton M. Lee
Registered Professional Surveyor No. 6181
February 6, 1987



ORIGINAL STAMP IN GREEN

INDEXED ON MAP
4933 HD

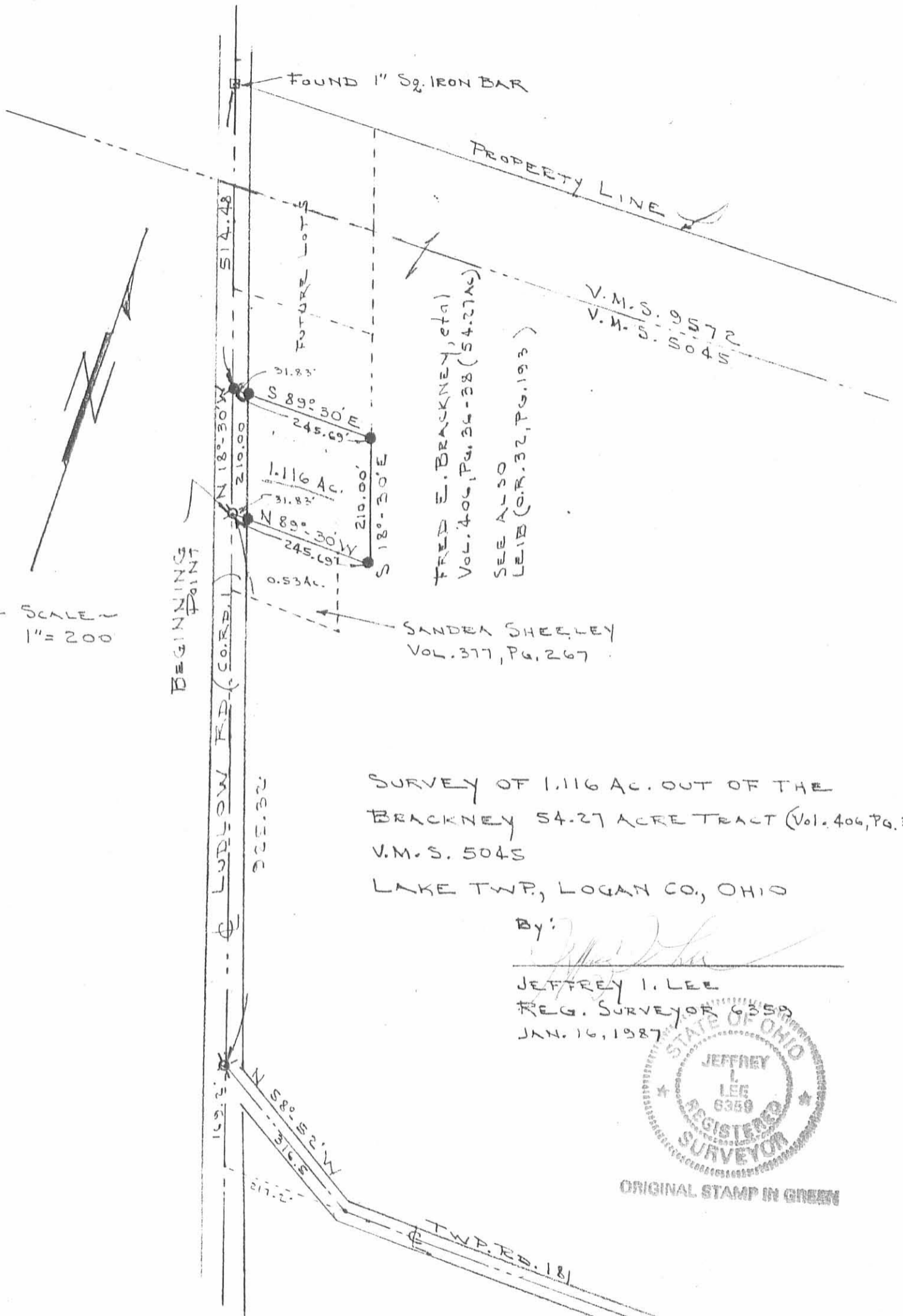

SCALE
1" = 200

BEGINNING POINT

FOUND 1" SQ. IRON BAR

PROPERTY LINE

V.M.S. 9572
V.M.S. 5045

FRED E. BRACKNEY, et al
Vol. 406, Pg. 36-38 (54.27 Ac.)
SEE ALSO
LEID (O.R. 32, Pg. 193)

SANDRA SHEELEY
Vol. 377, Pg. 267

SURVEY OF 1.116 AC. OUT OF THE
BRACKNEY 54.27 ACRE TRACT (Vol. 406, Pg. 36)
V.M.S. 5045
LAKE TWP, LOGAN CO, OHIO

By: *Jeffrey I. Lee*
JEFFREY I. LEE
REG. SURVEYOR 6359
JAN. 16, 1987



ORIGINAL STAMP IN GREEN

- ⊗ = RR SPIKE FOUND
- ⊗ = RR SPIKE SET
- = 1/2" IRON ROD SET

INDEXED ON MAP
49334P

L-1529-4

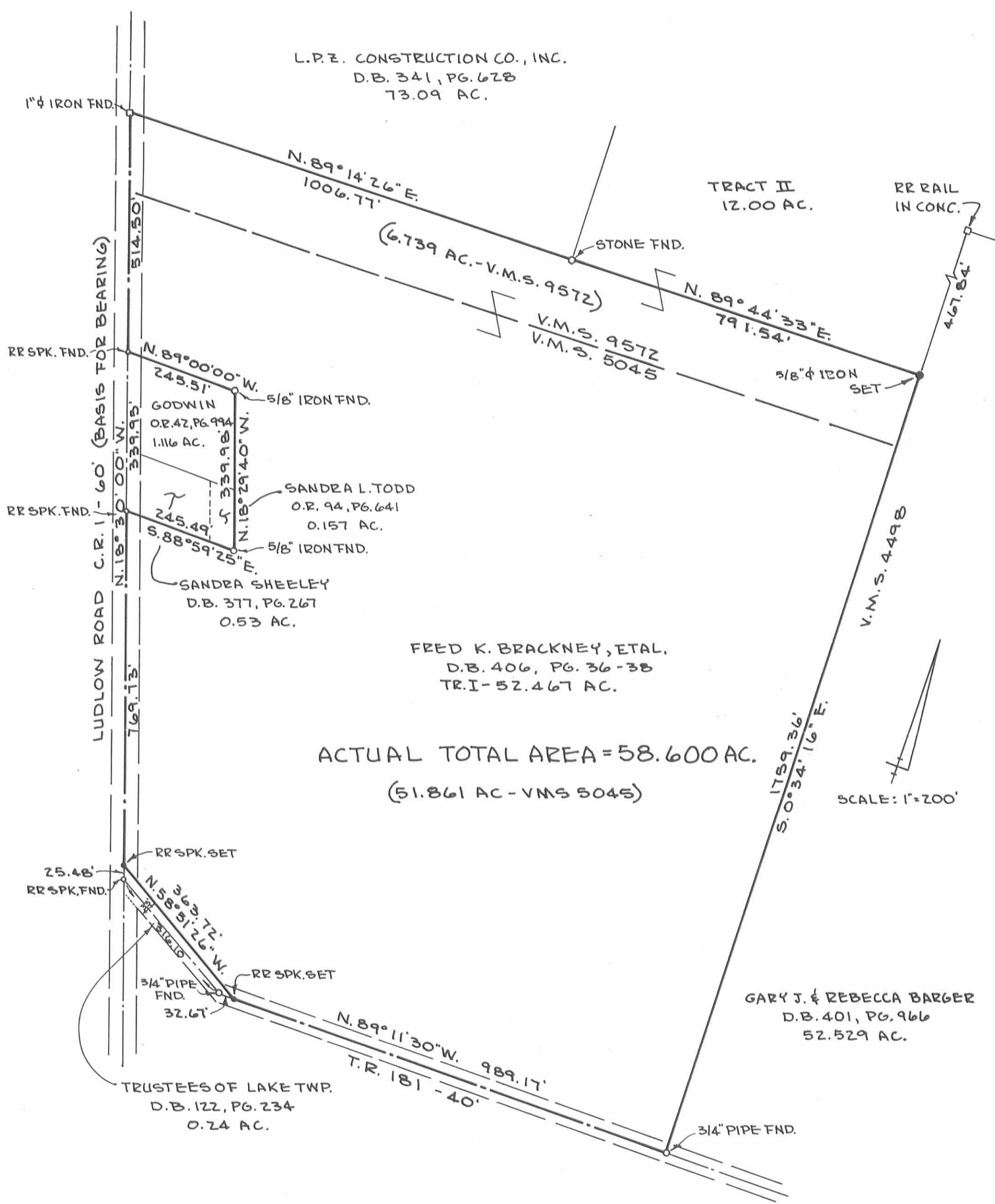

L.P.Z. CONSTRUCTION CO., INC.
 D.B. 341, PG. 628
 73.09 AC.

TRACT II
 12.00 AC.

RR RAIL
 IN CONC.

LUDLOW ROAD C.R. 11-60 (BASIS FOR BEARING)

ACTUAL TOTAL AREA = 58.600 AC.
 (51.861 AC - VMS 5045)

SCALE: 1" = 200'

BRACKNEY SURVEY
 V.M.S. 5045 & 9572
 LAKE TOWNSHIP
 LOGAN COUNTY, OHIO

SURVEY BY:
Richard A. Bruce
 RICHARD A. BRUCE, P.E., P.S.
 REG. PROF. SURVEYOR 6993
 APRIL - MAY, 1990



INDEXED ON MAP
 49.33 5P

BRACKNEY SURVEY
Y.M.S. 5045

LAKE TOWNSHIP

James

SEE F.B. 598 pg 26 FOR E
OF C.H. No. 1

INDEXED ON MAP
4933

Dodson
Nichols

1/22/72
430

56

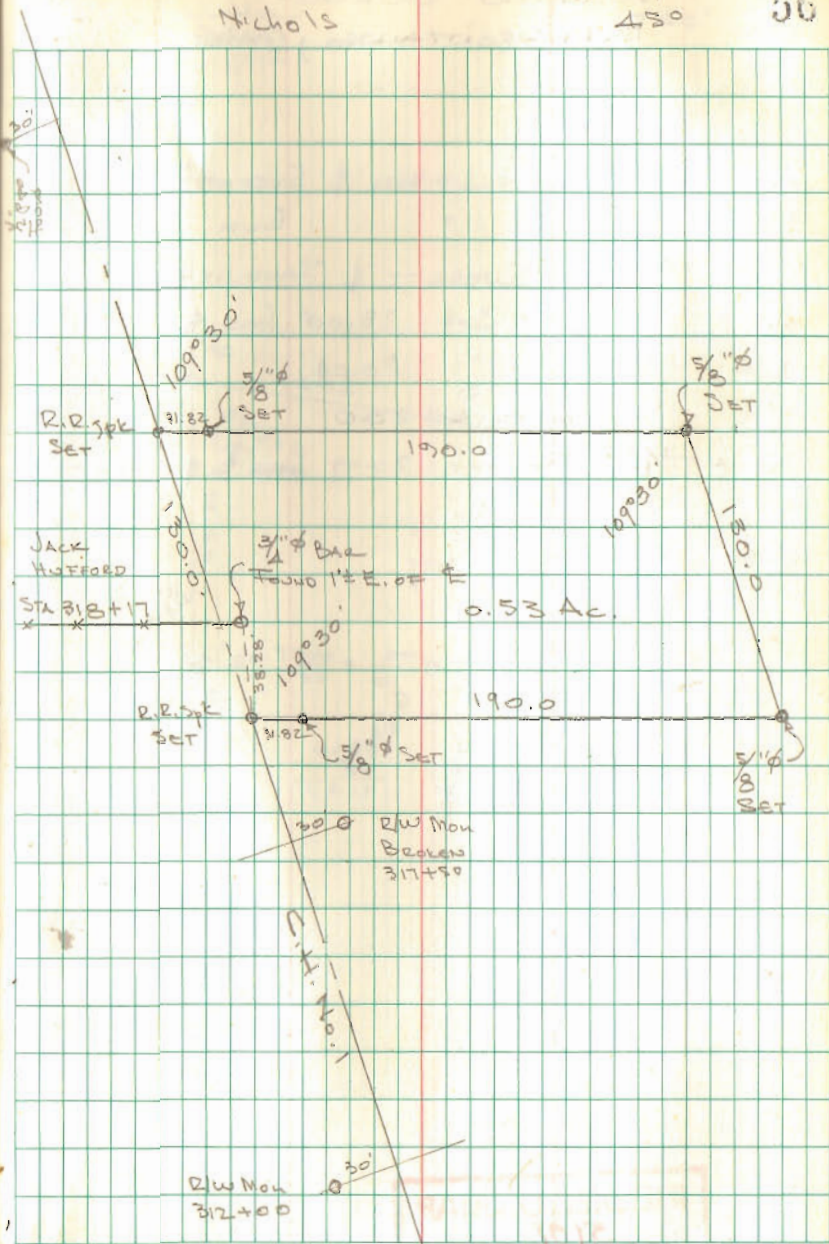

8-22-2022



Legal Description
70.475 acres

The following described tract of land is situated in the State of Ohio, Logan County, Lake Township, VMS 5045, VMS 9572 being all of LeVan Investments LLC's 58.727 acre Tract I and 12.000 acre Tract II described in Official Record 1408, page 2539 and being more particularly described as follows:

Commencing at a concrete resurvey monument found marking the intersection of the centerline of Lake Avenue with the centerline of Ludlow Road (C.R.1)(60');

Thence South 14°15'33" East 1186.05 feet, following the centerline of Ludlow Road and the west line of VMS 9572, to a 1" iron pipe found marking the northwest corner of said 58.727 acre Tract I and the southwest corner of The Board of Education of the Bellefontaine City School District's 64.782 acre Tract III (O.R. 966, page 572), in the Bellefontaine Corporation line and marking the **point of beginning**;

Thence **South 86°22'46" East 1005.96 feet**, following the north line of said 58.727 acre Tract I and the south line of 64.782 acre tract and said corporation line, passing at 31.52 feet an iron pin set, to a 5/8" iron pin found marking the southwest corner of said 12.000 acre Tract II;

Thence **North 03°31'45" East 660.49 feet**, following the west line of said 12.000 acre Tract II and the east line of said 64.782 acre tract and said corporation line, to a stone found;

Thence **South 86°22'28" East 794.57 feet**, following the north line of said 12.000 acre Tract II and the south line of said 64.782 acre tract and said corporation line, to a stone found in the west line of Timothy M. Sr. and Mary A. Smith's 17.205 acre tract (O.R. 435, page 667) and the east line of VMS 9572;

Thence **South 03°43'44" West 662.80 feet**, following the east line of VMS 9572, the east line of said 12.000 acre Tract II, the west line of said 17.205 acre tract and the west line of said Clinton M. Barger Trustee's 49.563 acre Tract III (O.R. 1153, page 945), to a 5/8" iron pin found marking the northeast corner of said 58.727 acre Tract I;

Thence **South 03°39'37" West 1759.59 feet**, following the east line of VMS 9572, VMS 5045, the east line of said 58.727 acre Tract I and the west line of said 49.653 acre Tract III, passing at 1739.59 feet an iron pin set, to a 3/4" iron pipe found in the centerline of Township Road 181 (33');

Thence **North 84°56'43" West 989.21 feet**, following the centerline of Township Road 181 and the south line of said 58.727 acre Tract I, to a railroad spike found;

Thence **North 54°38'32" West 363.81 feet**, following the south line of said 58.727 acre Tract I, departing from the centerline of Township Road 181, following the north right of way line of Township Road 181, to a railroad spike found in the centerline of Ludlow Road and the west line of VMS 5045;

Thence **North 14°15'33" West 769.80 feet**, following the centerline of Ludlow Road, the west line of VMS 5045 and the west line of said 58.727 acre Tract I, to a railroad spike found marking the southwest corner of Cody R. Wood's 0.53 acre Tract I (O.R. 1312, page 240);



Thence **South 84°45'49" East 245.62 feet**, following the south line of said 0.53 acre tract and the south line of Cody R. Wood's 0.157 acre Tract II (O.R. 1312, page 240), passing at 31.86 feet a 5/8" iron pin found, to a 3/4" iron pin found;

Thence **North 14°16'01" West 340.05 feet**, following the east line of said 0.157 acre tract and the east line of Tamara A. Allison, Trustee's 1.116 acre tract (O.R. 1153, page 951), to a 1/2" iron pin found;

Thence **North 84°45'16" West 245.58 feet**, following the north line of said 1.116 acre tract, passing at 213.72 feet a 1/2" iron pin found, to a railroad spike found in the centerline of Ludlow Road, the west line of VMS 5045 and the west line of said 58.727 acre Tract I;

Thence **North 14°15'33" West 514.41 feet**, following the centerline of Ludlow Road, the west line of VMS 5045, VMS 9572, and the west line of said 58.727 acre Tract I, to the *point of beginning*, containing **70.475 acres**, containing 18.706 acres in VMS 9572 and 51.769 acres in VMS 5045, with 1.275 acres within the road right of way. Subject to all valid easements and restrictions of record.

I, Timothy L. Guider, hereby certify that this description was prepared from an actual field survey made by me during the month of August 2022 and that monuments were set or found as indicated herein. Iron pins set are 5/8" x 30" reinforcing rods with caps marked "GUIDER S 7752". Basis of Bearing: State Plane Coordinate System, Ohio North Zone, NAD83.

Timothy L. Guider R.S. #7752
Guider Winkle Partners, Inc.
19550 Delaware County Line Rd.
Marysville, Ohio 43040
(740)666-8902



Date: 8/17/22
Job# 22199-70.475

INDEXED ON MAP
4933

APPROVED

Plat of Survey Guider Winkle Partners, Inc.

State of Ohio, Logan County, Lake Township
VMS 5045, VMS 9572

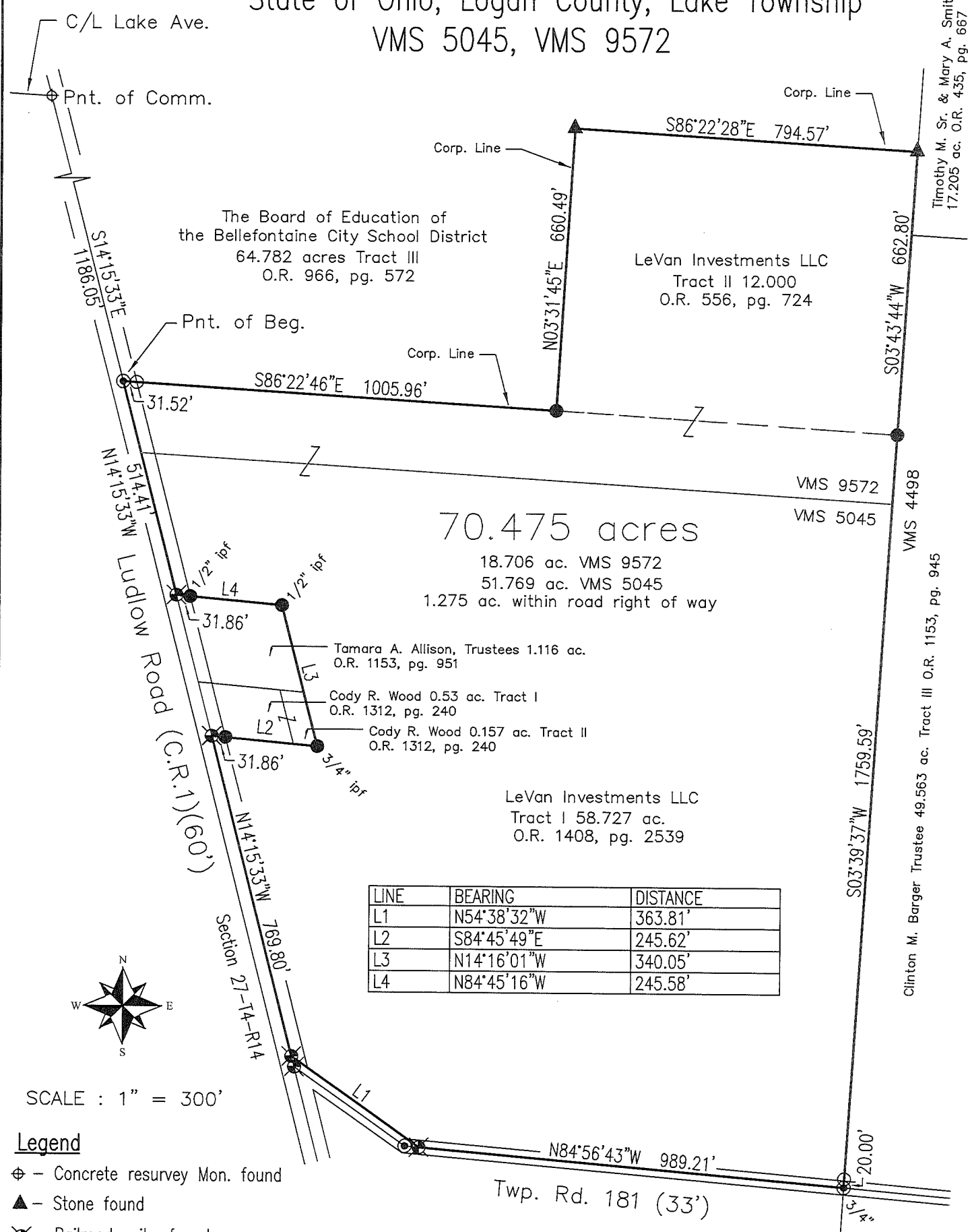

70.475 acres

18.706 ac. VMS 9572
51.769 ac. VMS 5045
1.275 ac. within road right of way

LINE	BEARING	DISTANCE
L1	N54°38'32"W	363.81'
L2	S84°45'49"E	245.62'
L3	N14°16'01"W	340.05'
L4	N84°45'16"W	245.58'

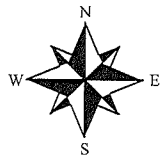

SCALE : 1" = 300'

Legend

- ⊕ - Concrete resurvey Mon. found
- ▲ - Stone found
- ⊗ - Railroad spike found
- - 5/8" Iron pin found or as noted
- ⊙ - 1" Iron pipe found or as noted
- - 5/8" x 30" Iron pin set with cap marked "GUIDER S 7752"

Basis of Bearing

State Plane Coordinate System
Ohio North Zone, NAD83

Scale in Feet



Surveyor's Certification

I hereby certify that this plat is an accurate representation of a field survey made by me and is correct to the best of my knowledge.

Timothy L. Guider

8/17/22

Timothy L. Guider R.S. #7752
Guider Winkle Partners, Inc.
19550 Delaware County Line Road
Marysville, Ohio 43040
(740)-666-8902

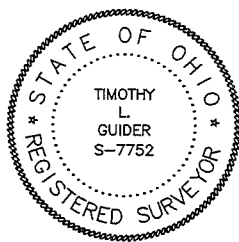

INDEXED ON MAP
4933

Job#22199

ANNEXATION DESCRIPTION
70.013 Acres

The following described tract of land is situated in the State of Ohio, Logan County, Lake Township, VMS 5045, VMS 9572 being part of LeVan Investments LLC's 58.727 acre Tract I and all of a 12.000 acre Tract II described in Official Record 1408, page 2539 and being more particularly described as follows:

Commencing at a concrete resurvey monument found marking the intersection of the centerline of Lake Avenue with the centerline of Ludlow Road (C.R.1) (60');
Thence South 14°15'33" East 1186.05 feet, following the centerline of Ludlow Road and the west line of VMS 9572, to a 1" iron pipe found marking the northwest corner of said 58.727 acre Tract I and the southwest corner of The Board of Education of the Bellefontaine City School District's 64.782 acre Tract III (O.R. 966, page 572), in the Bellefontaine Corporation line and marking the point of beginning;

Thence South 86°22'46" East 1005.96 feet, following the north line of said 58.727 acre Tract I, the south line of said 64.782 acre tract and said corporation line, passing at 31.52 feet an iron pin set, to a 5/8" iron pin found marking the southwest corner of said 12.000 acre Tract II;

Thence North 03°31'45" East 660.49 feet, following the west line of said 12.000 acre Tract II and the east line of said 64.782 acre tract and said corporation line, to a stone found;

Thence South 86°22'28" East 794.57 feet, following the north line of said 12.000 acre Tract II and the south line of said 64.782 acre tract and said corporation line, to a stone found in the west line of Timothy M. Sr. and Mary A. Smith's 17.205 acre Tract (O.R. 435, page 667) and the east line of VMS 9572;

Thence South 03°43'44" West 662.80 feet, following the east line of VMS 9572, the east line of said 12.000 acre Tract II, the west line of said 17.205 acre tract and the west line of said Clinton M. Barger Trustee's 49.563 acre Tract III (O.R. 1153, page 945), to a 5/8" iron pin found marking the northeast corner of said 58.727 acre Tract I;

Thence South 03°39'37" West 1739.59 feet, following the east line of VMS 9572, VMS 5045, the east line of said 58.727 acre Tract I and the west line of said 49.563 acre Tract III, to a iron pin set on the north right of way line of Township Road 181 (40');

Thence North 84°56'43" West 1022.94 feet, following the north right of way line of Township Road 181 and entering said 58.727 acre Tract I, to a point;

Thence North 54°38'32" West 324.18 feet, following the south line of said 58.727 acre Tract I, continuing with the north right of way line of Township Road 181 (33'), to a railroad spike found in the centerline of Ludlow Road and the west line of VMS 5045;

Thence North 14°15'33" West 769.80 feet, following the centerline of Ludlow Road, the west line of VMS 5045 and the west line of said 58.727 acre Tract I, to a railroad spike found marking the southwest corner of Katy Lyn Wright's 0.53 acre Tract I (O.R. 1408, page 5234);

Thence South 84°45'49" East 245.62 feet, following the south line of said 0.53 acre tract and the south line of Katy Lyn Wright's 0.157 acre Tract II (O.R. 1408, page 5234), passing at 31.86 feet a 5/8" iron pin found, to a 3/4" iron pin found;

Thence North 14°16'01" West 340.05 feet, following the east line of said 0.157 acre tract and the east line of Tamara A. Allison Trustee's 1.116 acre tract (O.R. 1153, page 951), to a 3/4" iron pin found;

Thence North 84°45'16" West 245.58 feet, following the north line of said 1.116 acre tract, passing at 213.72 feet a 3/4" iron pin found, to a railroad spike found in the centerline of Ludlow Road, the west line of VMS 5045 and the west line of said 58.727 acre Tract I;

Thence North 14°15'33" West 514.41 feet, following the centerline of Ludlow Road, the west line of VMS 5045, VMS 9572, and the west line of said 58.727 acre Tract I, to the point of beginning, containing 70.013 acres, containing 18.706 acres in VMS 9572 and 51.307 acres in VMS 5045, with 0.893 acres within the road right of way. Subject to all valid easements and restrictions of record.

I, Timothy L. Guider, hereby certify that this Annexation description was prepared from an actual field survey made by me during the month of August 2022 and that monuments were set or found as indicated herein. Iron pin sets are 5/8" x 30" reinforcing rods with caps marked "GUIDER S 7752". Basis of Bearing: State Plane Coordinate System, Ohio North Zone, NAD83.

Timothy L. Guider R.S. #7752 Date: 12/2/22
Guider Winkle Partners, Inc. Job# 22199-70.013
19541 Delaware County Line Rd.
Marysville, Ohio 43040
(740)666-8902

Surveyor's Certification
I hereby certify that this description and plat is an accurate representation for annexation purposes from a field survey made by me and is correct to the best of my knowledge.

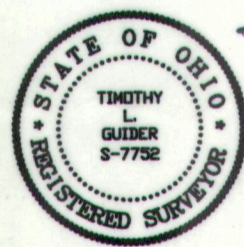

Timothy L. Guider 6-20-23
Timothy L. Guider R.S. #7752 Date
Guider Winkle Partners, Inc.
19541 Delaware County Line Road
Marysville, Ohio 43040
(740)666-8902 Job#22199

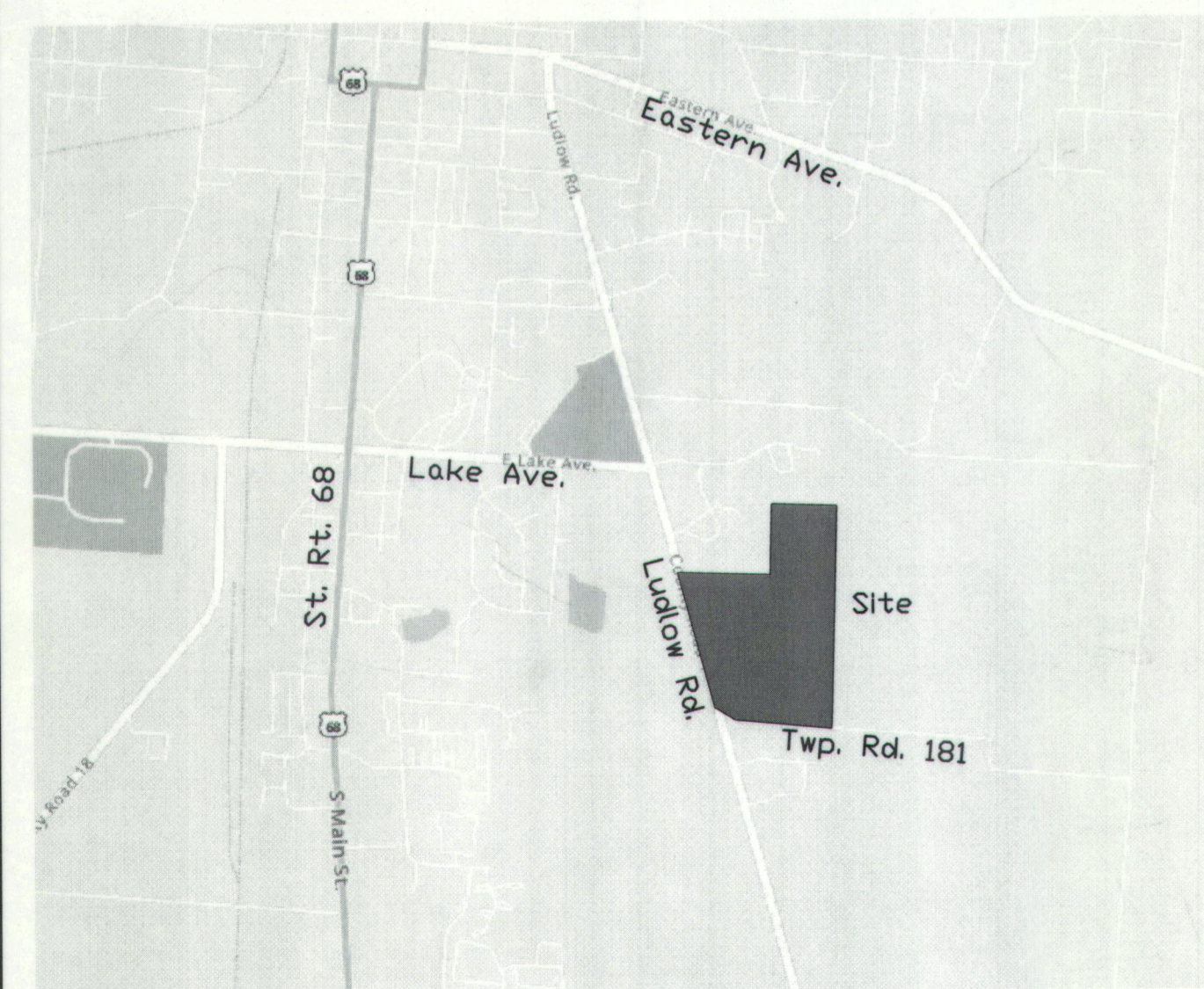

VICINITY MAP
(NO SCALE)

LINE	BEARING	DISTANCE
L1	N54°38'32"W	324.18'
L2	S84°45'49"E	245.62'
L3	N14°16'01"W	340.05'
L4	N84°45'16"W	245.58'



SCALE: 1" = 200'

Legend

- - Concrete resurvey Mon. Found
- ▲ - Stone Found
- ✕ - Railroad spike Found
- - 5/8" Iron pin found or as noted
- - 1" Iron pipe found or as noted
- - 5/8" x 30" Iron pin set with cap marked "GUIDER S 7752"

Basis of Bearing
State Plane Coordinate System
Ohio North Zone, NAD83

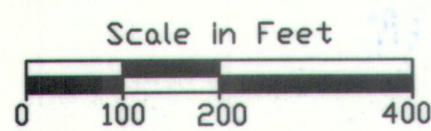

**PROPOSED ANNEXATION TO THE
CITY OF BELLEFONTAINE**
70.013 ACRES
VMS 5045 & VMS 9572
LAKE TOWNSHIP, LOGAN COUNTY, OHIO

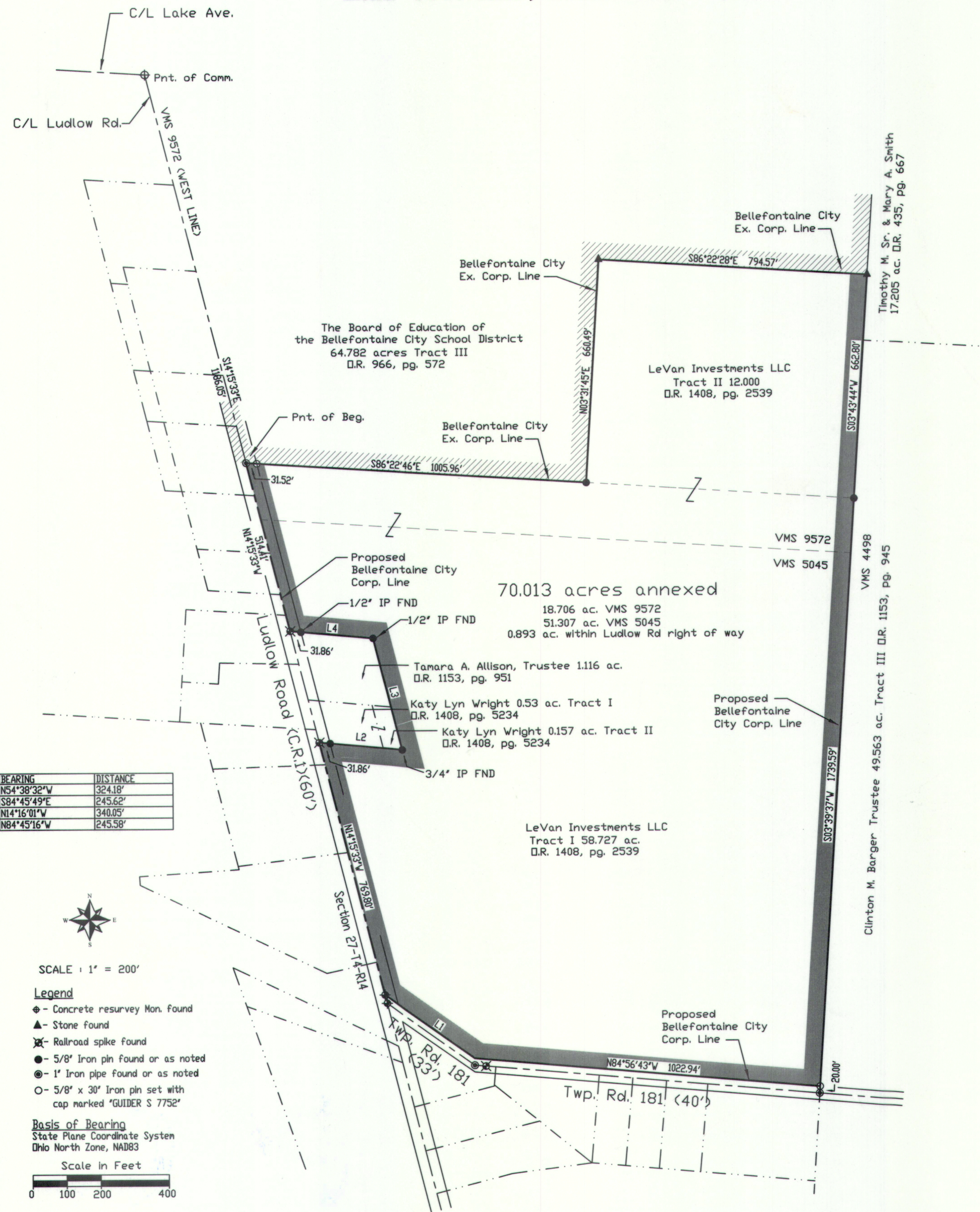

APPROVAL BY LOGAN COUNTY COMMISSIONERS

THE ANNEXATION OF THIS AREA WAS APPROVED THIS 15th DAY OF December, 2022, BY RESOLUTION No. 289-22.

[Signature]
LOGAN COUNTY COMMISSIONER

[Signature]
LOGAN COUNTY COMMISSIONER

[Signature]
LOGAN COUNTY COMMISSIONER

APPROVAL BY LOGAN COUNTY ENGINEER

THIS PLAT WAS REVIEWED AND APPROVED THIS 31st DAY OF January, 2024.

[Signature]
LOGAN COUNTY ENGINEER

APPROVAL BY LOGAN COUNTY MAPROOM

PLAT PRE-APPROVED

[Signature] 6-24-2023
LOGAN COUNTY MAPROOM DATE

PLAT CHECKED

[Signature] 2-1-2024
LOGAN COUNTY MAPROOM DATE

APPROVAL BY LAKE TOWNSHIP

THIS PLAT WAS REVIEWED AND APPROVED THIS 11 DAY OF July, 2023.

[Signature]
LAKE TOWNSHIP TRUSTEES CHAIRMAN

APPROVAL BY THE CITY OF BELLEFONTAINE

AT A MEETING OF THE CITY COUNCIL OF THE CITY OF BELLEFONTAINE HELD

THIS 28th DAY OF March, 2023 THE ANNEXATION OF THE TERRITORY SHOWN HEREON TO THE CITY OF BELLEFONTAINE

WAS APPROVED AND ACCEPTED BY ORDINANCE No. 23-16.

[Signature]
MAYOR

[Signature]
COUNCIL PRESIDENT

[Signature]
CLERK

LOGAN COUNTY AUDITOR

APPROVED AND TRANSFERRED 2-5, 2024.

[Signature]
LOGAN COUNTY AUDITOR

LOGAN COUNTY RECORDER

RECEIVED FOR RECORD AT 9:11 O'CLOCK, A.M.

THIS 5th DAY OF January, 2024.

RECORDED IN PLAT CABINET B, SLIDE 161A.

[Signature]
LOGAN COUNTY RECORDER

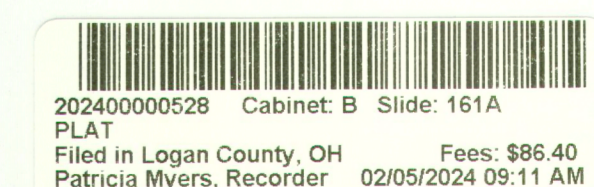

PREPARED BY: **Guider Winkle Partners, Inc.**

19541 Delaware County Line Rd Marysville, Ohio 43040
PH. (740) 666-8902
DRAWN BY: A.C.
FILE/CABINET: LUDLOW ZONING MAP

PROFESSIONAL STAMP:

REVISIONS:

DESCRIPTION:

DATE:

NO.:

SHEET NAME: **ANNEXATION MAP**
CITY OF BELLEFONTAINE, VMS 5045, 9572, LAKE TOWNSHIP

PREPARED FOR: **LEVAN INVESTMENTS LLC**
4198 US 68, WEST LIBERTY, OHIO 43057

SCALE:

DATE: 12/02/22

SHEET:

1.0

JOB # 22-199

FINAL PLAT LUDLOW RIDGE - PHASE ONE

BEING PART OF A 70.475 ACRE TRACT, LOCATED IN VMS 5045 AND VMS 9572, CITY OF BELLEFONTAINE, LAKE TOWNSHIP, LOGAN COUNTY, OHIO

22.626 ACRES

(10.807 ACRES IN LOTS & 8.642 ACRES IN OPEN SPACE LOTS & 3.177 ACRES IN STREET RIGHT OF WAY)

CITY OF BELLEFONTAINE APPROVALS

THE WITHIN PUBLIC RIGHT-OF-WAY AND EASEMENTS ARE HEREBY APPROVED AND ACCEPTED FOR PUBLIC MAINTENANCE BY ORDINANCE NO. 24-79 RECORDED IN CITY'S RECORD BOOK ON THIS DAY OF October 22, 2024.

Dan Curran 10-22-24
MAYOR OF BELLEFONTAINE DATE

[Signature] 10-22-24
PRESIDENT, BELLEFONTAINE CITY COUNCIL DATE

Bonnie Dossin 10-22-24
CLERK, BELLEFONTAINE CITY COUNCIL DATE

[Signature] 10-22-24
BELLEFONTAINE CITY ENGINEER DATE

[Signature] 10-7-2024
CHAIRMAN, BELLEFONTAINE PLANNING COMMISSION DATE

LOGAN COUNTY APPROVALS

PLAT PRE-APPROVED

[Signature] 10-7-2024
SIGNATURE DATE

PLAT CHECKED

[Signature] 10-25-2024
SIGNATURE DATE

LOGAN COUNTY AUDITOR

TRANSFERRED THIS DAY OF 10-28, 2024.

[Signature]
LOGAN COUNTY AUDITOR

LOGAN COUNTY RECORDER

FILED FOR RECORD THIS DAY OF October 28, 2024 AT 2:18 p.m.

RECORDED THIS DAY OF October 28, 2024 AT 2:18 p.m.

PLAT CABINET B, SLIDES 163B-164B

[Signature]
LOGAN COUNTY RECORDER

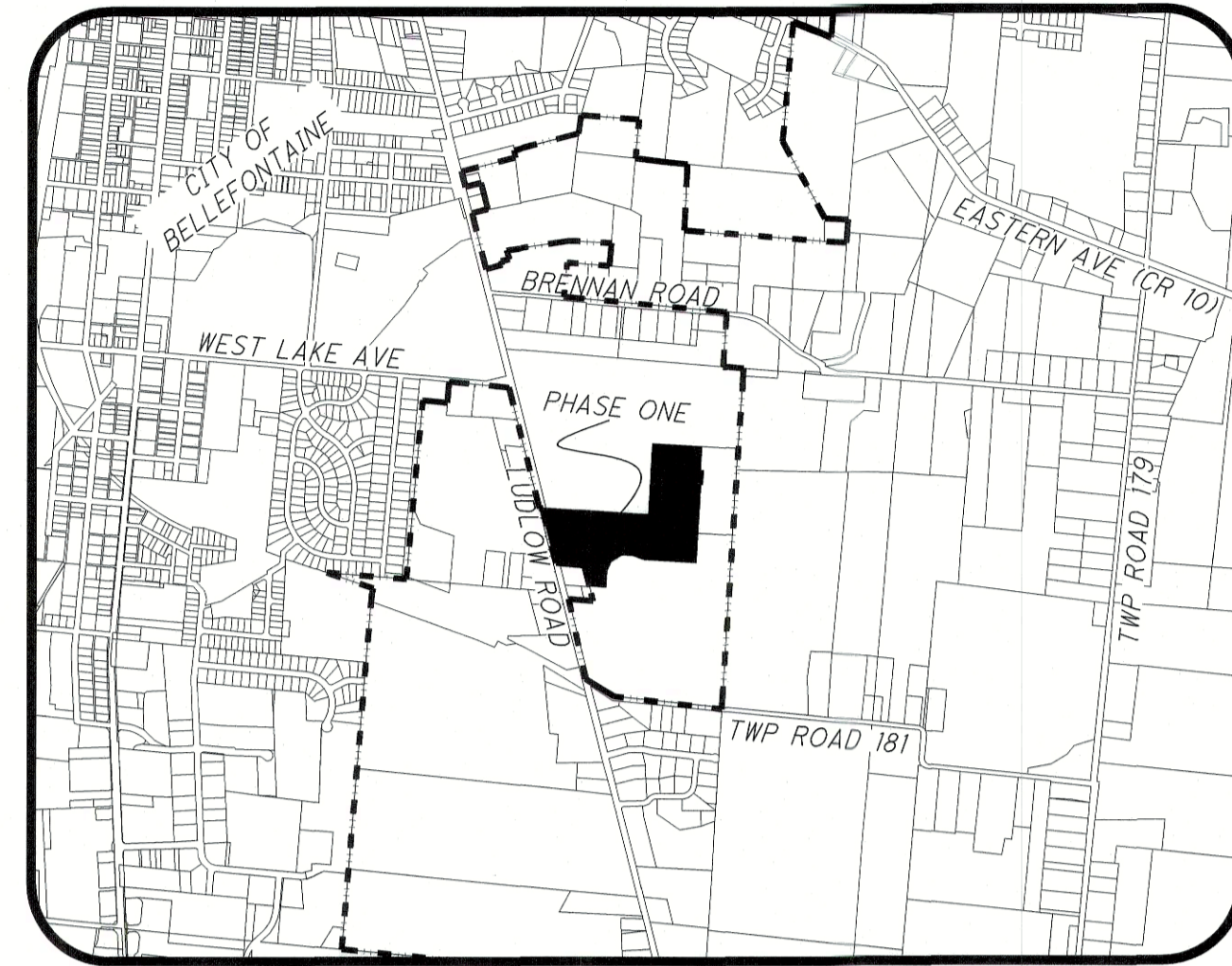

VICINITY MAP
NOT TO SCALE

DEDICATION

WE THE UNDERSIGNED BEING ALL THE OWNERS OF THE LAND HEREIN SUBDIVIDED DO HEREBY ACKNOWLEDGE THE MAKING AND SIGNING OF THIS FINAL PLAT TO BE OUR VOLUNTARY ACT AND DEED, AND DO HEREBY DEDICATE THE STREETS AND RESERVE THE EASEMENTS SHOWN ON THE WITHIN PLAT TO THE PUBLIC USE FOREVER.

UTILITY EASEMENTS SHOWN ON THIS PLAT ARE FOR THE CONSTRUCTION, OPERATION, MAINTENANCE, REPAIR, REPLACEMENT AND/OR REMOVAL OF WATER LINE, STORM SEWERS, SANITARY SEWERS, DRAINAGE SWALES, GAS, ELECTRIC, TELEPHONE, CABLE TELEVISION, OR OTHER LINES OR SERVICES AND FOR THE EXPRESS PRIVILEGE OF REMOVING ANY OR ALL TREES OR OTHER OBSTRUCTIONS TO THE FREE USE OF SAID EASEMENT AND FOR PROVIDING INGRESS TO AND EGRESS FROM THE PREMISES FOR SAID PURPOSES AND ARE TO BE MAINTAINED AS SUCH FOREVER.

EASEMENTS ARE RESERVED FOR THE PUBLIC'S USE FOREVER. THE SHERWOOD LOOP RIGHT-OF-WAY IS HEREBY DEDICATED TO THE PUBLIC'S USE FOREVER.

SIGNED AND ACKNOWLEDGED IN THE PRESENCE OF: LUDLOW RIDGE INVESTMENTS, LLC

Jeffrey Baur
PRINTED NAME

LUDLOW RIDGE INVESTMENTS, LLC

[Signature]
SIGNATURE

Authorized Signatory
TITLE

STATE OF Ohio
COUNTY OF Franklin

THE FOREGOING INSTRUMENT WAS ACKNOWLEDGED BEFORE ME THIS 28th of Oct., 2024 BY Jeffrey Baur OF LUDLOW RIDGE INVESTMENT LLC, AN OHIO LIMITED LIABILITY COMPANY, ON BEHALF OF THE LIMITED LIABILITY COMPANY.

NOTARY PUBLIC [Signature]



DESCRIPTION

BEING A TRACT OF LAND SITUATE IN THE STATE OF OHIO, LOGAN COUNTY, CITY OF BELLEFONTAINE, LAKE TOWNSHIP, VMS 5045 AND VMS 9572, BEING PART OF LUDLOW RIDGE INVESTMENTS LLC, 70.475 ACRES AS DESCRIBED IN OFFICIAL RECORD 1418, PAGE 13 AND BEING MORE PARTICULARLY DESCRIBED AS FOLLOWS:

COMMENCING AT A CONCRETE SURVEY MONUMENT FOUND MARKING THE INTERSECTION OF THE CENTERLINE OF LAKE AVENUE WITH THE CENTERLINE OF LUDLOW ROAD (COUNTY ROAD 1), AND BEING THE NORTHEAST CORNER OF SECTION 27, TOWN 4, RANGE 14;
THENCE SOUTH 14°16'01" EAST 116.05 FEET, ALONG THE CENTERLINE OF LUDLOW ROAD AND THE WEST LINE OF VMS 9572, TO A RAILROAD SPIKE FOUND MARKING THE NORTHWEST CORNER OF SAID 70.475 ACRE TRACT AND THE SOUTHWEST CORNER OF THE BOARD OF EDUCATION OF THE BELLEFONTAINE CITY SCHOOL DISTRICT, 64.782 ACRES AS DESCRIBED IN OFFICIAL RECORD 966, PAGE 572, TRACT III, BEING THE PRINCIPAL POINT OF BEGINNING;
THENCE SOUTH 86°22'46" EAST 1005.95 FEET, ALONG THE SOUTH LINE OF SAID SCHOOL DISTRICT TRACT, TO A 5/8" IRON PIN FOUND, PASSING A 5/8" IRON PIN FOUND AT 31.52 FEET;
THENCE NORTH 03°31'45" EAST 660.49 FEET, ALONG THE EAST LINE OF SAID SCHOOL DISTRICT TRACT, TO A STONE FOUND;
THENCE SOUTH 86°22'28" EAST 461.65 FEET, ALONG THE SOUTH LINE OF SAID SCHOOL DISTRICT TRACT, TO AN IRON PIN SET;
THENCE SOUTH 03°40'11" WEST 160.35 FEET, ALONG THE NEW SUBDIVISION LINE, TO AN IRON PIN SET;
THENCE SOUTH 86°19'48" EAST 22.23 FEET, ALONG THE NEW SUBDIVISION LINE, TO AN IRON PIN SET;
THENCE, SOUTHEASTERLY, ALONG A CURVE TO THE RIGHT HAVING A LENGTH OF 11.61 FEET, A RADIUS OF 180.00 FEET, A DELTA ANGLE OF 03°41'44" AND A CHORD OF 11.61 FEET BEARING SOUTH 84°28'57" EAST, TO AN IRON PIN SET;
THENCE SOUTH 07°21'55" WEST 60.00 FEET, ALONG THE NEW SUBDIVISION LINE, TO AN IRON PIN SET;
THENCE SOUTH 03°40'11" WEST 129.75 FEET, ALONG THE NEW SUBDIVISION LINE, TO AN IRON PIN SET;
THENCE NORTH 86°19'49" WEST 17.73 FEET, ALONG THE NEW SUBDIVISION LINE, TO AN IRON PIN SET;
THENCE SOUTH 03°40'11" WEST 731.57 FEET, ALONG THE NEW SUBDIVISION LINE, TO AN IRON PIN SET;
THENCE NORTH 86°19'49" WEST 490.00 FEET, ALONG THE NEW SUBDIVISION LINE, TO AN IRON PIN SET;
THENCE NORTH 69°37'52" WEST 104.40 FEET, ALONG THE NEW SUBDIVISION LINE, TO AN IRON PIN SET;
THENCE NORTH 86°19'48" WEST 108.47 FEET, ALONG THE NEW SUBDIVISION LINE, TO AN IRON PIN SET;
THENCE SOUTH 59°27'37" WEST 116.94 FEET, ALONG THE NEW SUBDIVISION LINE, TO AN IRON PIN SET;
THENCE SOUTH 25°15'04" WEST 94.68 FEET, ALONG THE NEW SUBDIVISION LINE, TO AN IRON PIN SET;
THENCE SOUTH 03°40'11" WEST 154.80 FEET, ALONG THE NEW SUBDIVISION LINE, TO AN IRON PIN SET;
THENCE NORTH 85°26'40" WEST 179.71 FEET, ALONG THE NEW SUBDIVISION LINE, TO A 5/8" IRON PIN FOUND AT THE SOUTHEAST CORNER OF TAMARA A. ALLISON TRUSTEE TRACT, 1.116 ACRES AS DESCRIBED IN OFFICIAL RECORD 1153, PAGE 951;
THENCE NORTH 14°16'01" WEST 210.05 FEET, ALONG THE EAST LINE OF SAID ALLISON ACRE TRACT, AND THE BELLEFONTAINE CORPORATION LINE TO A 5/8" IRON PIN FOUND;
THENCE NORTH 84°45'16" WEST 245.58 FEET, ALONG THE NORTH LINE OF SAID ALLISON TRACT, AND THE BELLEFONTAINE CORPORATION LINE TO A MAG NAIL SET IN THE CENTERLINE OF LUDLOW ROAD (COUNTY ROAD 1) AND THE WEST LINE OF VMS 5045, PASSING A 5/8" IRON PIN FOUND AT 213.75 FEET;
THENCE NORTH 14°15'33" WEST 514.41 FEET, ALONG THE CENTERLINE OF LUDLOW ROAD (COUNTY ROAD 1) AND THE WEST LINE OF VMS 5045 AND VMS 9572, TO THE POINT OF BEGINNING, CONTAINING 22.626 ACRES, HAVING 12.678 ACRES IN VMS 9572 AND 9.948 ACRES IN VMS 5045.

ALL IRON PINS SET ARE 30" IN LENGTH, 5/8" DIAMETER WITH A PLASTIC CAP STAMPED "C.O.E.C./AJB 8629".

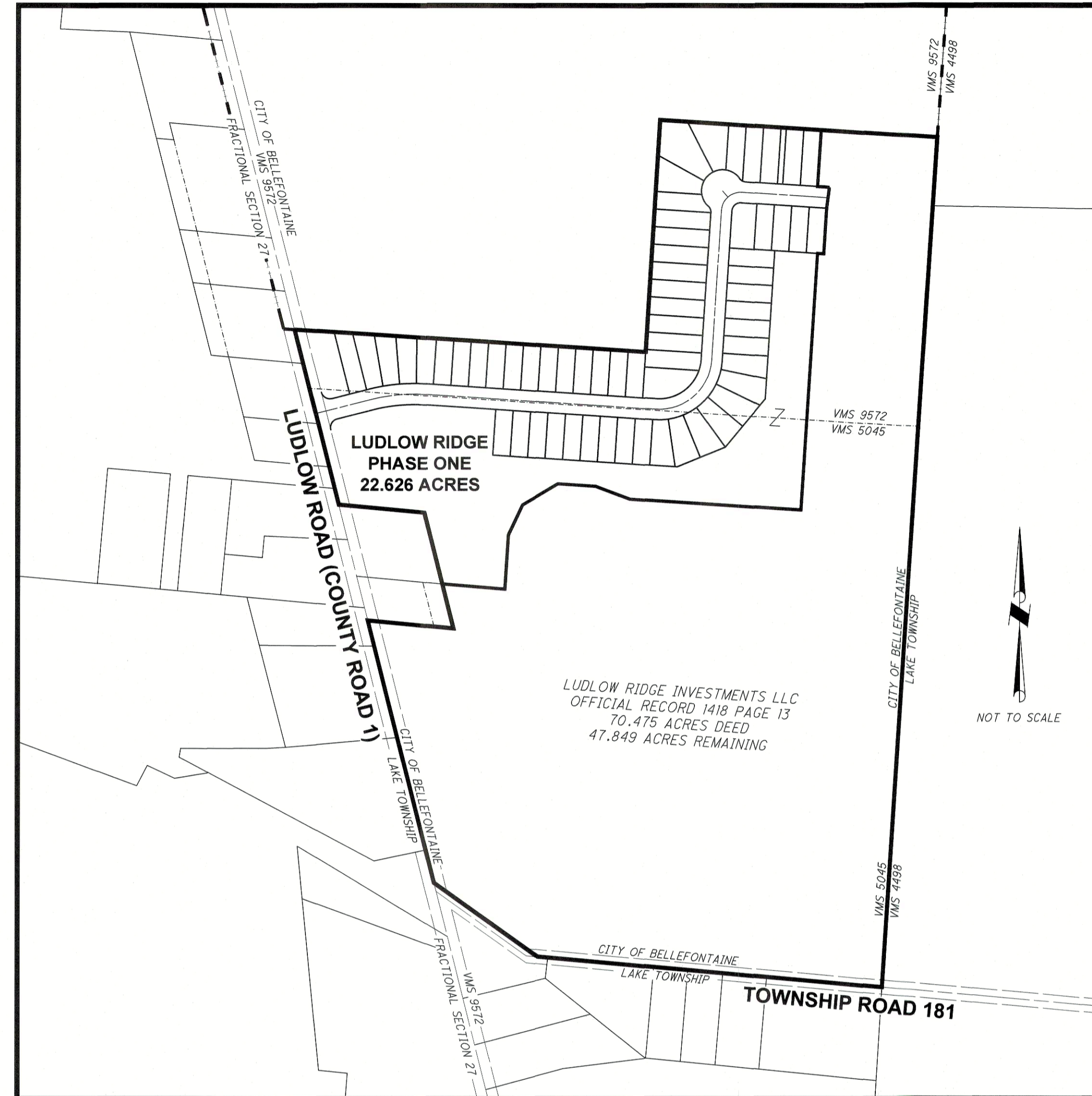

SUPERIMPOSED AREA MAP

ALL THE LANDS OF THE DEDICATOR OF SUCH PLAT ARE DRAWN AS SHOWN HEREON

LUDLOW RIDGE INVESTMENTS LLC OFFICIAL RECORD 1418 PAGE 13

ORIGINAL BY SURVEY 70.475 ACRES (DEED)

THIS PLAT - LUDLOW RIDGE - PHASE ONE 22.626 ACRES
REMAINING NOT PLATTED 47.849 ACRES
70.475 ACRES

LOT	ACREAGE BREAKDOWN		TOTAL
	V.M.S. 9572	V.M.S. 5045	
1	0.197	0.003	0.200
50	0.163	0.021	0.184
51	0.053	0.131	0.184
52	0.006	0.178	0.184
64	1.354	6.889	8.243
65	0.307	0.037	0.344
R/W	2.146	0.387	3.133

LUDLOW RIDGE PHASE ONE SUMMARY

63 RESIDENTIAL LOTS 10.807 ACRES
3 OPEN AREA LOTS 8.642 ACRES
DEDICATED STREET R/W 3.177 ACRES
TOTAL 22.626 ACRES

OWNER/DEVELOPER

LUDLOW RIDGE INVESTMENTS LLC
4198 US HIGHWAY 68 S
WEST LIBERTY, OHIO 43357

CERTIFICATION

THE ACCOMPANYING PLAT REPRESENTS LUDLOW RIDGE-PHASE ONE, BEING 12.634 ACRES OUT OF V.M.S. 9572 AND 9.948 ACRES OUT OF V.M.S. 5045 TOTALING 22.582 ACRES. ALSO REPRESENTS THE DEDICATION OF SHERWOOD LOOP IN VIRGINIA MILITARY SURVEY 4045 AND 9572, IN THE CITY OF BELLEFONTAINE, LAKE TOWNSHIP, LOGAN COUNTY, OHIO. THE STREETS HAVE A TOTAL AREA OF 3.177 ACRES OF WHICH 2.822 ACRES ARE IN SHERWOOD LOOP AND 0.355 ACRES ARE IN LUDLOW ROAD. ALL MEASUREMENTS ARE IN FEET AND DECIMAL PARTS THEREOF. ALL MEASUREMENTS OF CURVES ARE ALONG THE ARC. I HEREBY CERTIFY THAT THE ACCOMPANYING PLAT IS A CORRECT REPRESENTATION OF LUDLOW RIDGE PHASE ONE AS SURVEYED IN FEBRUARY OF 2024, AND THAT ALL MONUMENTS SHOWN HEREON HAVE BEEN FOUND, SET, OR WILL BE SET UPON COMPLETION OF CONSTRUCTION AND FINAL GRADING.

Allen J. Bertke
ALLEN J. BERTKE, P.S. #8629

10-7-24
DATE

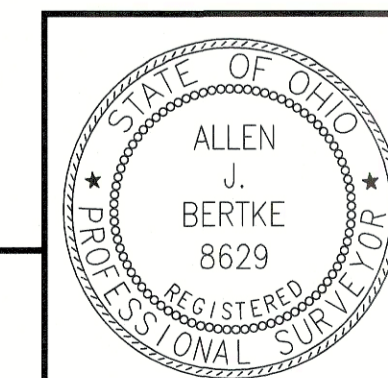

PREPARED BY:
Choice One Engineering
SIDNEY, OHIO 937-497-0200
LOVELAND, OHIO 513.239.8534
WWW.CHOICEONEENGINEERING.COM

DATE: 10-07-2024
DRAWN BY: RAP
JOB NUMBER: LOGBEL2305
SHEET NUMBER: 1 OF 3

FINAL PLAT LUDLOW RIDGE - PHASE ONE

BEING PART OF A 70.475 ACRE TRACT, LOCATED IN VMS 5045 AND VMS 9572,
CITY OF BELLEFONTAINE, LAKE TOWNSHIP, LOGAN COUNTY, OHIO

22.626 ACRES

(10.807 ACRES IN LOTS & 8.642 ACRES IN OPEN SPACE LOTS &
3.177 ACRES IN STREET RIGHT OF WAY)

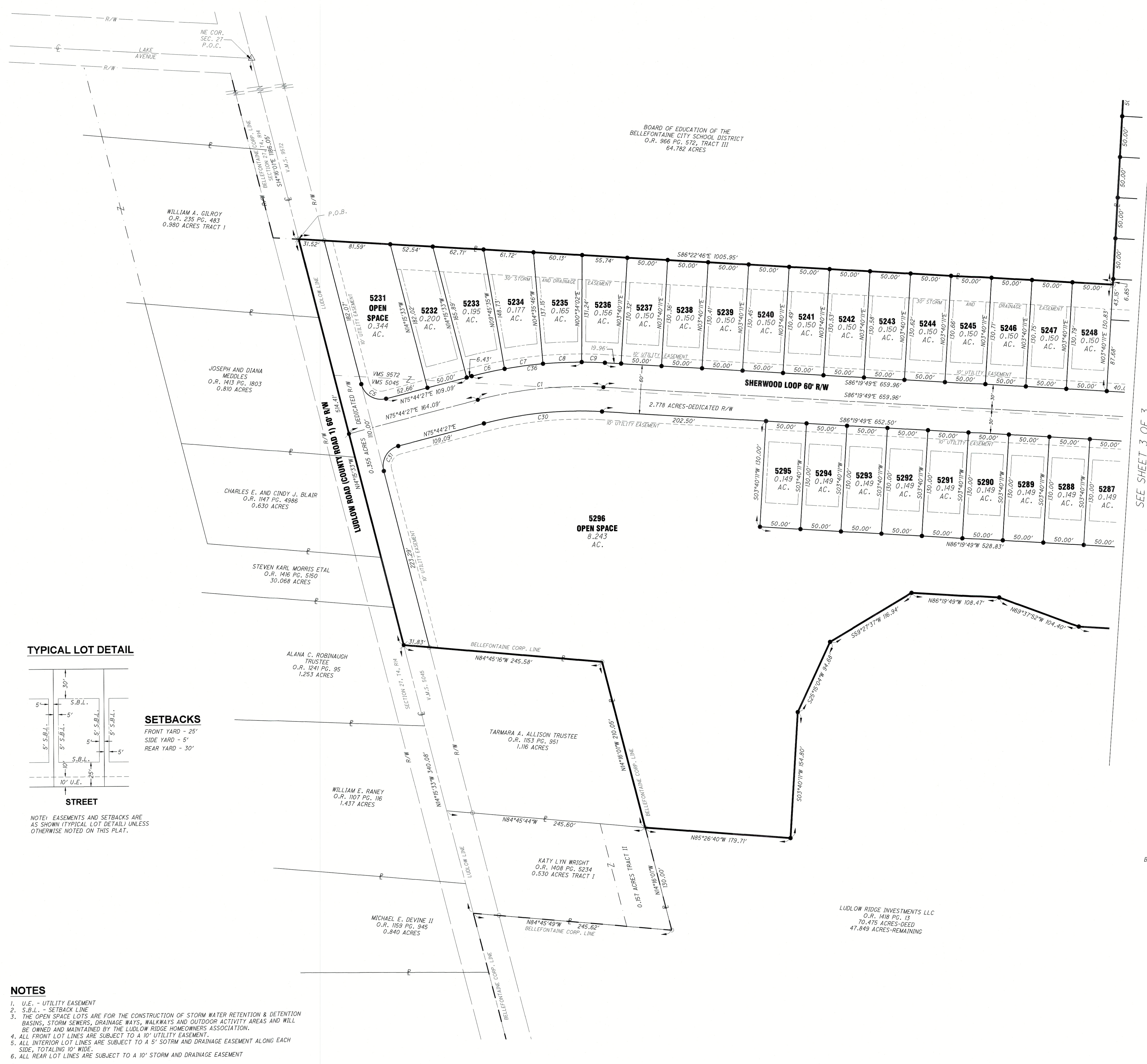

CURVE TABLE					
CURVE	RADIUS	LENGTH	DELTA	CH DIST	CH BEARING
C1	500.00'	156.46'	17°55'44"	155.82'	N84°42'19"E
C2	150.00'	235.62'	90°00'00"	212.13'	N48°40'11"E
C3	55.00'	43.20'	45°00'00"	42.10'	N26°10'11"E
C4	55.00'	43.20'	45°00'00"	42.10'	N71°10'11"E
C5	25.00'	39.27'	90°00'00"	35.36'	S59°15'33"E
C6	530.00'	41.62'	0°42'58"	41.61'	N77°52'26"E
C7	530.00'	47.76'	05°09'49"	47.75'	N82°48'19"E
C8	530.00'	47.76'	05°09'49"	47.75'	N87°59'08"E
C9	530.00'	28.70'	03°08'08"	28.69'	S87°52'54"E
C10	120.00'	155.78'	74°22'41"	145.07'	N56°28'50"E
C11	120.00'	32.72'	15°37'19"	32.62'	N11°28'50"E
C13	25.00'	20.59'	47°11'23"	20.01'	N22°33'05"W
C12	25.00'	1.15'	02°37'34"	1.15'	S02°21'24"W
C14	60.00'	38.25'	36°31'35"	37.61'	N27°53'00"W
C15	60.00'	40.00'	38°11'40"	39.26'	N09°28'38"E
C16	60.00'	35.95'	34°19'56"	35.42'	N45°44'25"E
C17	60.00'	37.41'	35°43'28"	36.81'	N80°46'07"E
C18	60.00'	46.97'	44°51'18"	45.78'	S58°56'30"E
C19	25.00'	11.72'	26°51'48"	11.61'	S49°56'45"E
C20	25.00'	10.02'	22°57'09"	9.95'	S74°51'14"E
C21	120.00'	7.74'	03°41'44"	7.74'	S84°28'57"E
C21A	150.00'	9.67'	03°41'44"	9.67'	S84°28'57"E
C21B	180.00'	11.61'	03°41'44"	11.61'	S84°28'57"E
C22	25.00'	39.27'	90°00'00"	35.36'	N48°40'11"E
C23	180.00'	25.23'	08°10'48"	25.21'	N07°41'05"E
C24	180.00'	44.01'	14°00'34"	43.90'	N18°42'16"E
C25	180.00'	44.01'	14°00'34"	43.90'	N32°42'50"E
C26	180.00'	44.01'	14°00'34"	43.90'	N46°43'24"E
C27	180.00'	44.01'	14°00'34"	43.90'	N60°43'58"E
C28	180.00'	44.01'	14°00'34"	43.90'	N74°44'32"E
C29	180.00'	37.46'	11°55'21"	37.39'	N87°42'30"E
C30	470.00'	147.07'	17°55'44"	146.47'	N84°42'19"E
C31	25.00'	39.27'	90°00'00"	35.36'	N30°44'27"E
C32	55.00'	90.58'	94°21'56"	80.69'	S48°40'11"W
C33	180.00'	282.74'	90°00'00"	254.56'	S48°40'11"W
C34	120.00'	188.50'	90°00'00"	169.71'	N48°40'11"E
C35	60.00'	198.58'	189°37'56"	119.58'	N48°40'11"E
C36	530.00'	187.69'	20°17'23"	186.71'	N85°53'09"E
C37	25.00'	21.74'	49°48'58"	21.06'	S61°25'20"E
C38	25.00'	21.74'	49°48'58"	21.06'	N21°14'18"W

LINE TABLE		
LINE	LENGTH	BEARING
L1	22.23'	S86°19'48"E
L2	17.73'	N86°19'49"W
L3	23.00'	N41°19'49"W

TYPICAL LOT DETAIL

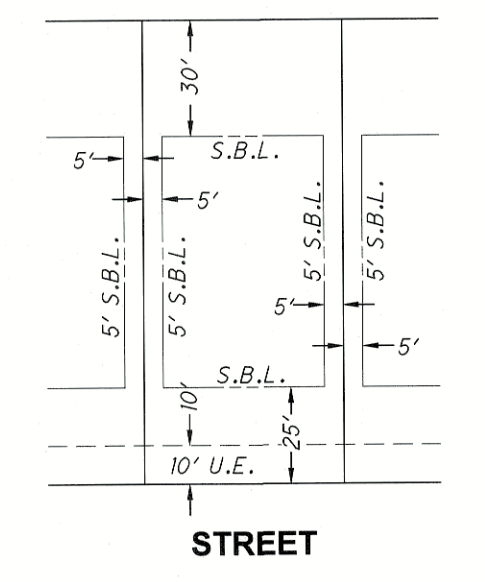

SETBACKS
FRONT YARD - 25'
SIDE YARD - 5'
REAR YARD - 30'

NOTE: EASEMENTS AND SETBACKS ARE AS SHOWN (TYPICAL LOT DETAIL) UNLESS OTHERWISE NOTED ON THIS PLAT.

NOTES

1. U.E. - UTILITY EASEMENT
2. S.B.L. - SETBACK LINE
3. THE OPEN SPACE LOTS ARE FOR THE CONSTRUCTION OF STORM WATER RETENTION & DETENTION BASINS, STORM SEWERS, DRAINAGE WAYS, WALKWAYS AND OUTDOOR ACTIVITY AREAS AND WILL BE OWNED AND MAINTAINED BY THE LUDLOW RIDGE HOMEOWNERS ASSOCIATION.
4. ALL FRONT LOT LINES ARE SUBJECT TO A 10' UTILITY EASEMENT.
5. ALL INTERIOR LOT LINES ARE SUBJECT TO A 5' SOTRM AND DRAINAGE EASEMENT ALONG EACH SIDE, TOTALING 10' WIDE.
6. ALL REAR LOT LINES ARE SUBJECT TO A 10' STORM AND DRAINAGE EASEMENT

SEE SHEET 3 OF 3

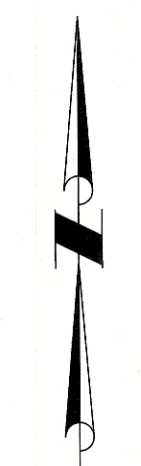

BEARINGS FOR THIS SURVEY WERE BASED ON CENTERLINE OF LUDLOW ROAD (COUNTY ROAD 1), BEING N4°15'33"W, NAD 83 CORRS 2011 ADJUSTMENTS, OHIO NORTH ZONE, CDDT VRS CORRS NETWORK

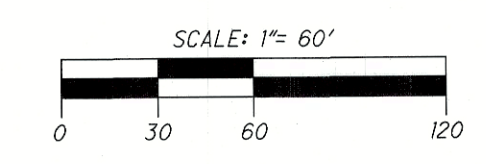

LEGEND

- 5/8" X 30" REBAR W/CAP SET (C.O.E.C./A/B LS-8629)
- IRON PIN FOUND (5/8" DIA.)
- △ CONCRETE MONUMENT FOUND
- ✦ MAG NAIL SET
- ✧ MAG NAIL FOUND
- ⊠ STONE FOUND
- ⊙ IRON PIPE FOUND 1"
- ⊞ MONUMENT BOX W/IP FOUND
- ⊚ RAILROAD SPIKE FOUND
- C111 CURVE NUMBER
- L111 LINE NUMBER
- UTILITY EASEMENT
- SETBACK LINE
- CORPORATION LINE

20240005310 Cairnet B Slide 164A
PLAT
Filed in Logan County, OH Fees: \$259.20
Patricia Myers, Recorder 10/28/2024 02:18 PM

ALLEN J. BERTKE
8629

PREPARED BY:

ChoiceOne
Engineering

SIDNEY, OHIO 937.497.0200
LOVELAND, OHIO 513.239.8554
www.CHOICEONEENGINEERING.com

DATE:
10-07-2024

DRAWN BY:
RAP

JOB NUMBER:
LOGBEL2305

SHEET NUMBER:
2 OF 3

FINAL PLAT LUDLOW RIDGE - PHASE ONE

BEING PART OF A 70.475 ACRE TRACT, LOCATED IN VMS 5045 AND VMS 9572,
CITY OF BELLEFONTAINE LAKE TOWNSHIP, LOGAN COUNTY, OHIO

22.626 ACRES

(10.807 ACRES IN LOTS & 8.642 ACRES IN OPEN SPACE LOTS &
3.177 ACRES IN STREET RIGHT OF WAY)

TIMOTHY M. SMITH SR. ETUX
O.R. 435 PG. 867
17.205 ACRES

NOTES

1. U.E. - UTILITY EASEMENT
2. S.B.L. - SETBACK LINE
3. THE OPEN SPACE LOTS ARE FOR THE CONSTRUCTION OF STORM WATER RETENTION & DETENTION BASINS, STORM SEWERS, DRAINAGE WAYS, WALKWAYS AND OUTDOOR ACTIVITY AREAS AND WILL BE OWNED AND MAINTAINED BY THE LUDLOW RIDGE HOMEOWNERS ASSOCIATION.
4. ALL FRONT LOT LINES ARE SUBJECT TO A 10' UTILITY EASEMENT.
5. ALL INTERIOR LOT LINES ARE SUBJECT TO A 5' SOTRM AND DRAINAGE EASEMENT ALONG EACH SIDE, TOTALING 10' WIDE.
6. ALL REAR LOT LINES ARE SUBJECT TO A 10' STORM AND DRAINAGE EASEMENT

TYPICAL LOT DETAIL

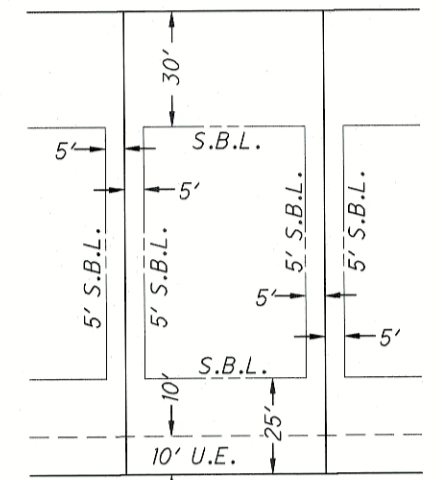

NOTE: EASEMENTS AND SETBACKS ARE AS SHOWN (TYPICAL LOT DETAIL) UNLESS OTHERWISE NOTED ON THIS PLAT.

SETBACKS

FRONT YARD - 25'
SIDE YARD - 5'
REAR YARD - 30'

BOARD OF EDUCATION OF THE
BELLEFONTAINE CITY SCHOOL DISTRICT
O.R. 966 PG. 572 TRACT III
64.782 ACRES

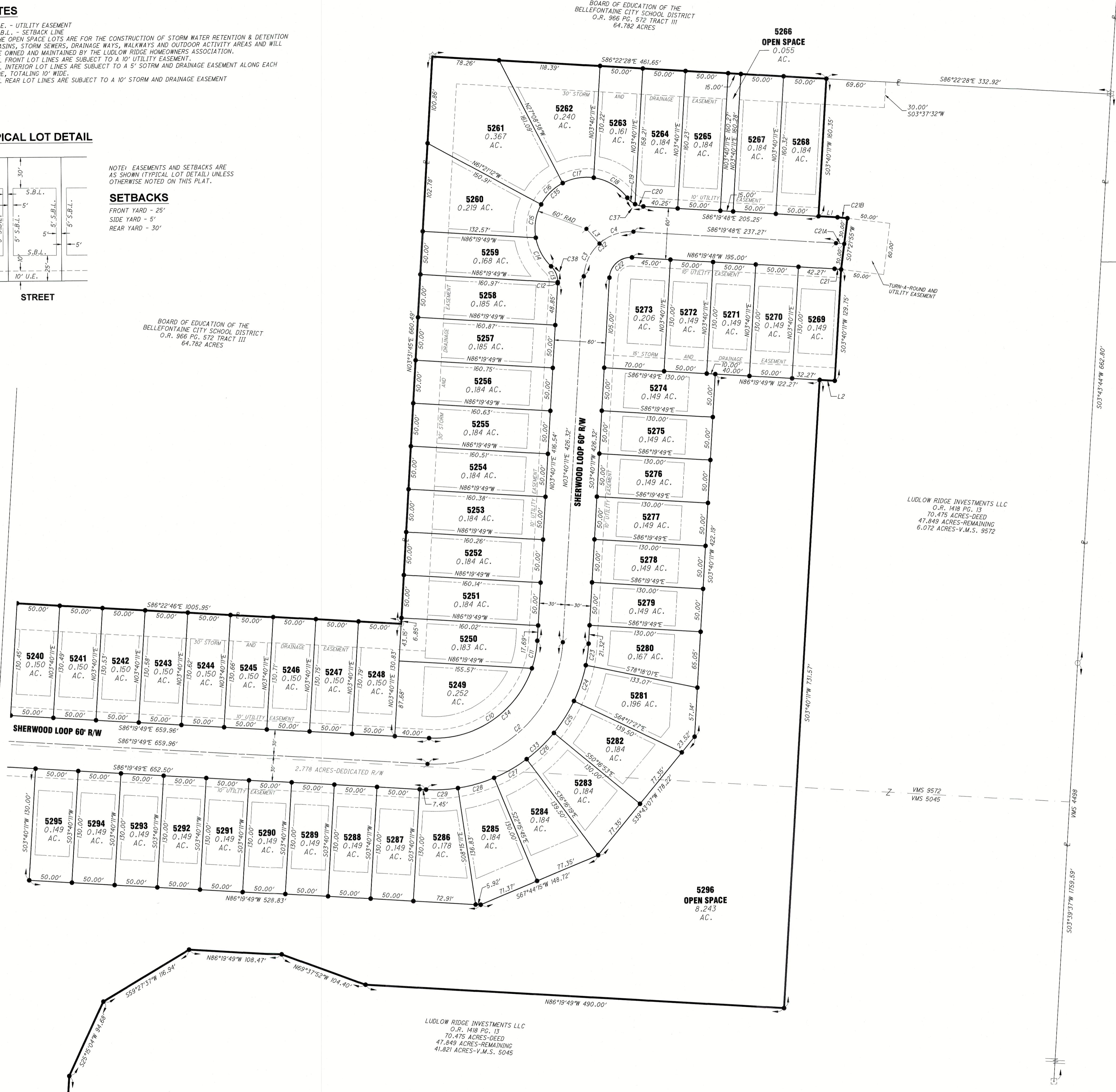

CURVE TABLE					
CURVE	RADIUS	LENGTH	DELTA	CH DIST	CH BEARING
C1	500.00'	156.46'	17°55'44"	155.82'	N84°42'19"E
C2	150.00'	235.62'	90°00'00"	212.13'	N48°40'11"E
C3	55.00'	43.20'	45°00'00"	42.10'	N26°10'11"E
C4	55.00'	43.20'	45°00'00"	42.10'	N71°10'11"E
C5	25.00'	39.27'	90°00'00"	35.36'	S59°15'33"E
C6	530.00'	41.62'	04°28'58"	41.61'	N77°59'26"E
C7	530.00'	47.76'	05°09'49"	47.75'	N82°49'19"E
C8	530.00'	47.76'	05°09'49"	47.75'	N87°59'08"E
C9	530.00'	28.70'	03°06'08"	28.69'	S87°52'54"E
C10	120.00'	155.78'	74°22'41"	145.07'	N56°28'50"E
C11	120.00'	32.72'	15°37'19"	32.62'	N11°28'50"E
C13	25.00'	20.59'	47°11'23"	20.01'	N22°33'05"W
C12	25.00'	1.15'	02°37'34"	1.15'	S02°21'24"W
C14	60.00'	38.25'	36°31'35"	37.61'	N27°53'00"W
C15	60.00'	40.00'	38°11'40"	39.26'	N09°28'38"E
C16	60.00'	35.95'	34°19'56"	35.42'	N45°44'25"E
C17	60.00'	37.41'	35°43'28"	36.81'	N80°46'07"E
C18	60.00'	46.97'	44°51'18"	45.78'	S58°56'30"E
C19	25.00'	11.72'	26°51'48"	11.61'	S49°56'45"E
C20	25.00'	10.02'	22°57'09"	9.95'	S74°51'14"E
C21	120.00'	7.74'	03°41'44"	7.74'	S84°28'57"E
C21A	150.00'	9.87'	03°41'44"	9.87'	S84°28'57"E
C21B	180.00'	11.61'	03°41'44"	11.61'	S84°28'57"E
C22	25.00'	39.27'	90°00'01"	35.36'	N48°40'11"E
C23	180.00'	25.23'	08°01'48"	25.21'	N07°41'05"E
C24	180.00'	44.01'	14°00'34"	43.90'	N18°42'16"E
C25	180.00'	44.01'	14°00'34"	43.90'	N32°42'50"E
C26	180.00'	44.01'	14°00'34"	43.90'	N46°43'24"E
C27	180.00'	44.01'	14°00'34"	43.90'	N60°43'58"E
C28	180.00'	44.01'	14°00'34"	43.90'	N74°44'32"E
C29	180.00'	37.46'	11°55'21"	37.39'	N87°42'30"E
C30	470.00'	147.07'	17°55'44"	146.47'	N84°42'19"E
C31	25.00'	39.27'	90°00'00"	35.36'	N30°44'27"E
C32	55.00'	90.58'	94°21'56"	80.69'	S48°40'11"W
C33	180.00'	282.74'	90°00'00"	254.56'	S48°40'11"W
C34	120.00'	188.50'	90°00'00"	169.71'	N48°40'11"E
C35	60.00'	198.58'	189°37'56"	119.58'	N48°40'11"E
C36	530.00'	187.69'	20°17'23"	186.71'	N85°53'09"E
C37	25.00'	21.74'	49°48'58"	21.06'	S61°25'20"E
C38	25.00'	21.74'	49°48'58"	21.06'	N21°14'18"W

LINE TABLE		
LINE	LENGTH	BEARING
L1	22.24'	S86°19'48"E
L2	17.73'	N86°19'49"W
L3	23.00'	N41°19'49"W

SEE SHEET 2 OF 3

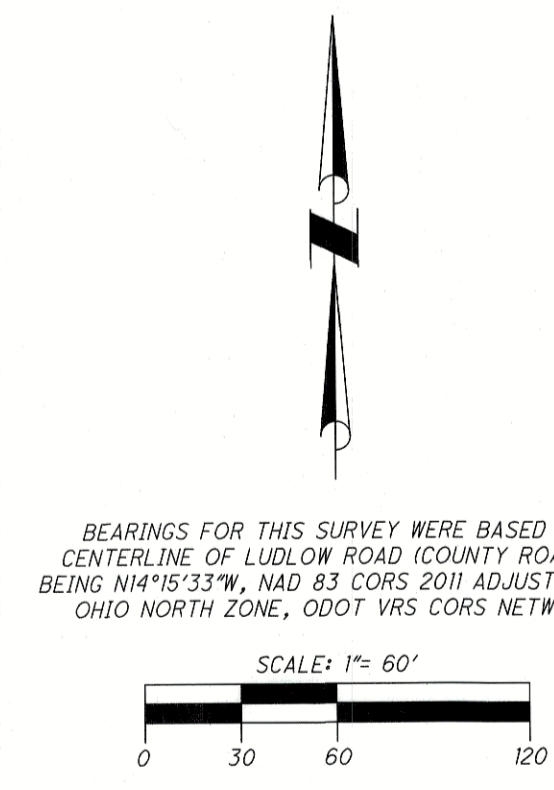

BEARINGS FOR THIS SURVEY WERE BASED ON
CENTERLINE OF LUDLOW ROAD (COUNTY ROAD 1),
BEING N11°15'33"W, HAD 83 CORRS 2011 ADJUSTMENTS,
OHIO NORTH ZONE, ODOT VRS CORRS NETWORK

- ### LEGEND
- 5/8" X 30" REBAR W/CAP SET (C.O.E.C./A/B LS-8629)
 - IRON PIN FOUND (5/8" DIA.)
 - △ CONCRETE MONUMENT FOUND
 - ✦ MAG NAIL SET
 - ✧ MAG NAIL FOUND
 - ⊠ STONE FOUND
 - ⊙ IRON PIPE FOUND 1"
 - ⊞ MONUMENT BOX W/IP FOUND
 - ⊟ RAILROAD SPIKE FOUND
 - C111 CURVE NUMBER
 - L111 LINE NUMBER
 - UTILITY EASEMENT
 - - - SETBACK LINE
 - CORPORATION LINE

20240005310 Cabinet: B Slide: 1648
PLAT
Filed in Logan County, OH Fees: \$259.20
Patricia Myers, Recorder 10/28/2024 02:18 PM

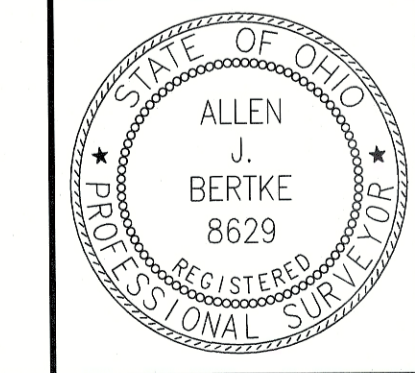

PREPARED BY:
ChoiceOne
Engineering
SIDNEY, OHIO 937.497.0200
LOVELAND, OHIO 513.239.8554
www.CHOICEONEENGINEERING.com

DATE:
10-07-2024
DRAWN BY:
RAP
JOB NUMBER:
LOGBEL2305
SHEET NUMBER
3 OF 3