

REC'D 10-11-07 SWM/RL

CURVE	DELTA ANGLE	RADIUS	ARC LENGTH	TANGENT	CHORD LENGTH	CHORD BEARING
C1	24°54'53"	1620.11'	704.49'	357.90'	698.95'	S 43°19'52" E

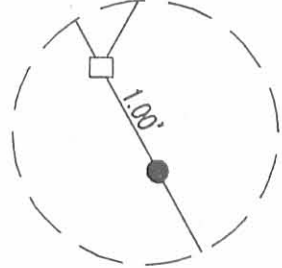
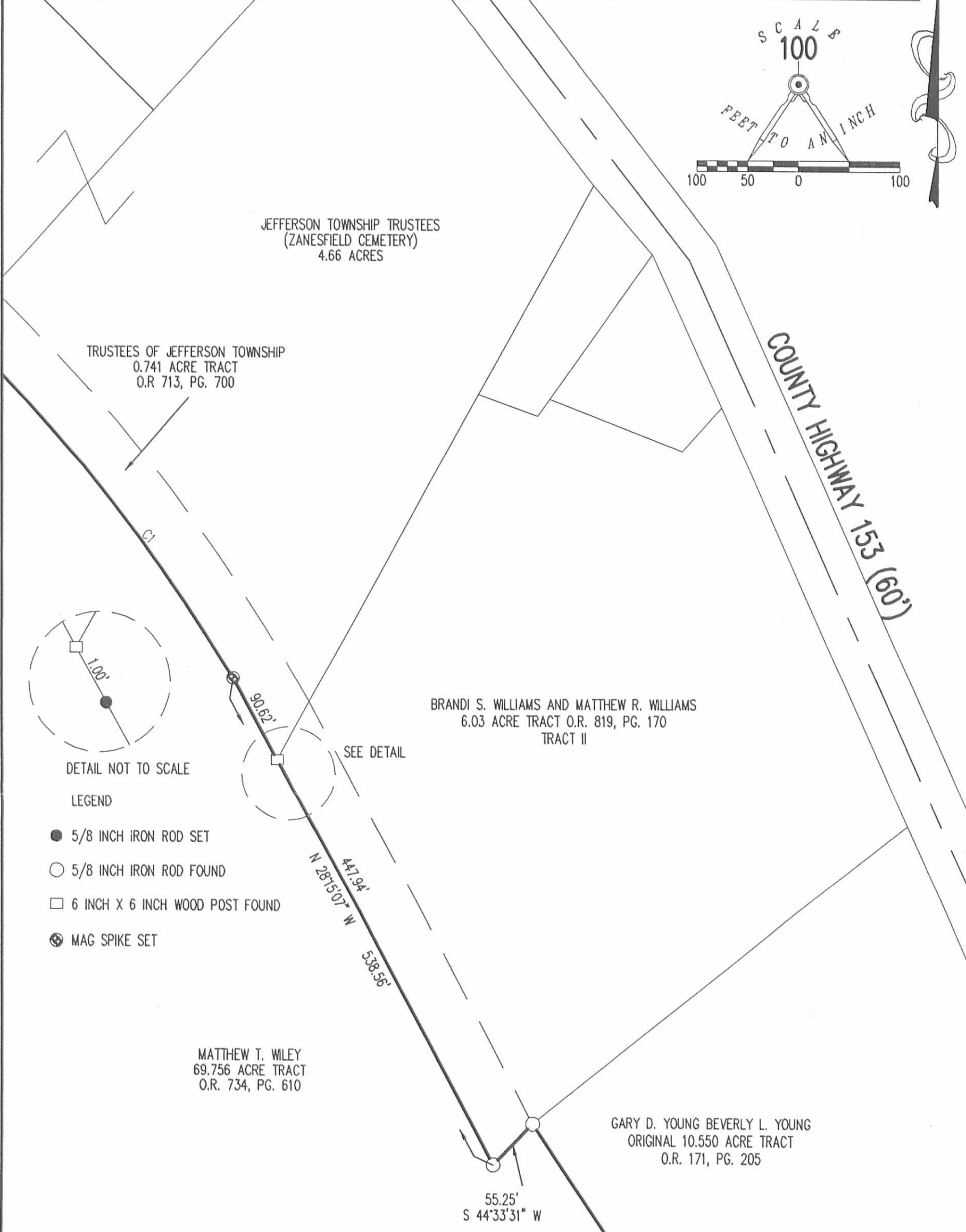
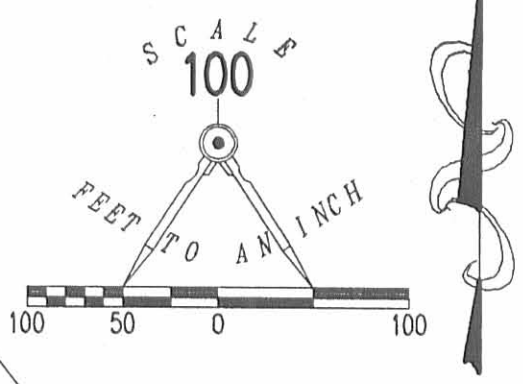

DETAIL NOT TO SCALE

LEGEND

- 5/8 INCH IRON ROD SET
- 5/8 INCH IRON ROD FOUND
- 6 INCH X 6 INCH WOOD POST FOUND
- ⊗ MAG SPIKE SET

**A PARTIAL RETRACEMENT SURVEY OF THE
MATTHEW T. WILEY
69.756 ACRE TRACT
OFFICIAL RECORD 734, PAGE 610
VIRGINIA MILITARY SURVY 3137
JEFFERSON TOWNSHIP
LOGAN COUNTY, OHIO**



ORIGINAL STAMP IN GREEN

SURVEYED BY:

William K. Bruce

WILLIAM K. BRUCE
PROFESSIONAL SURVEYOR 7437
OCTOBER 2, 2007

2 WORKING DAYS
BEFORE YOU DIG
CALL TOLL FREE **800-362-2764**
OHIO UTILITIES PROTECTION SERVICE.

INDEXED ON MAP
2070 1P

COPYRIGHT 2007 BY:
LEE SURVEYING & MAPPING CO., INC.
117 North Madriver Street
BELLEFONTAINE, OHIO 43311
(937) 593-7335
surveys@lsminc.us
ADW D1007 3712107 L-3712107-3

Lee Surveying and Mapping Co., Inc.

Land Surveys • Topography • Subdivisions • Construction Layout

117 N. Madriver St.
Bellefontaine OH 43311



Phone: (937) 593-7335
Fax: (937) 593-7444

BLACK 182.810 ACRE TRACT

Lying in Virginia Military Survey 3137, Jefferson Township, Logan County, Ohio

Being all of the remainder of the Curtis A. Black, Jr. and Joyce A. Black original 165 acre tract, 18 acre tract, 3.2 acre tract, and 3.78 acre tract (Tract I), all of the 0.51 acre tract (Tract II), and all of the 0.15 acre tract (Tract III) as deeded and described in Official Record 426, Page 406 of the Logan County Records of Deeds and being more particularly described as follows:

Beginning at a 5/8 inch iron rod set at the southeast corner of Virginia Military Survey 3137.

THENCE, with the south line of Virginia Military Survey 3137 the following two courses:

With the north line of the Donald L. Van Hyning 51.16 acre tract (O.R. 161, Pg. 204, Tract III), N 70°-35'-06" W, a distance of 1428.30 feet to a 5/8 inch iron rod found.

With the north line of the Michael L. Berry 60.69 acre tract (O.R. 215, Pg. 343), N 70°-10'-10" W, a distance of 1999.80 feet to a 12 inch square concrete post with a metal bar found in top.

THENCE, with the east line of the Zanesfield Rod and Gun Club, Inc. original 8.52 acre tract (Vol. 302, Pg. 381 and Vol. 299, Pg. 124, Tr. 8), N 17°-43'-23" E, a distance of 971.03 feet to a 5/8 inch iron rod set, passing a 5/8 inch iron rod set at 817.92 feet.

THENCE, with the said 8.52 acre tract and the Zanesfield Rod and Gun Club, Inc. 0.52 acre tract (Vol. 302, Page 381, Tract 15), S 72°-52'-34" E, a distance of 46.00 feet to a 5/8 inch iron rod set.

THENCE, with the east line of the said 0.52 acre tract, N 17°-43'-23" E, a distance of 996.31 feet to a 5/8 inch iron rod set, passing a 5/8 inch iron rod set at 193.77 feet.

THENCE, with the southerly lines of the Zanesfield Rod and Gun Club, Inc. original 6.2 acre tract (Vol. 163, Pg. 582, First Parcel) and the Zanesfield Rod and Gun Club 9.051 acre tract (Vol. 407, Pg. 789) with a curve to the right having a central angle of 28°-51'-43", a radius of 1470.11 feet, an arc distance of 740.54 feet, and having a chord bearing N 76°-16'-44" E, a distance of 732.74 feet to a 5/8 inch iron rod set.

THENCE, with the east lines of the said 9.051 acre tract the following three courses:

N 18°-37'-51" E, a distance of 236.76 feet to a 5/8 inch iron rod set.

N 28°-11'-38" E, a distance of 54.50 feet to a 1 inch iron pipe found.

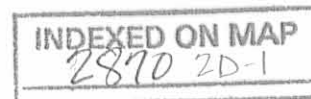

Lee Surveying and Mapping Co., Inc.

Land Surveys • Topography • Subdivisions • Construction Layout

117 N. Madriver St.
Bellefontaine OH 43311



Phone: (937) 593-7335
Fax: (937) 593-7444

N 32°-43'-00" E, a distance of
found, passing a 5/8 inch iron rod set at 792.52 feet.

822.62 feet to a railroad spike

THENCE, with the center-line of County Highway 153 (60 feet wide), S 52°-37'-36"E, a distance of 847.00 feet to a MAG nail set.

THENCE, with the west line of the Meredith S. Coder 2.808 acre tract (O.R. 671, Pg. 69) and the Joyce A. Black 1.002 acre tract (O.R. 426, Pg. 418), S 29°-20'-40" W, a distance of 666.05 feet to a point, passing a 5/8 inch iron rod set at 30.30 feet and a 5/8 inch iron rod found at 640.52 feet.

THENCE, with the southerly lines of the said 1.002 acre tract, the south line of the Jefferson Township Trustees original 2.012 acre tract (O.R. 72, Pg. 287), and the Jefferson Township Trustees (Zanesfield Cemetery) 4.66 acre tract, with a curve to the right having a central angle of 24°-54'-53", an arc length of 704.49 feet, a radius of 1620.11 feet and a chord bearing S 43°-19'-52" E, a distance of 698.95 feet to a 5/8 inch iron rod set.

THENCE, continuing with the south line of the said 4.66 acre tract, and the David Scott Elson 6.03 acre tract (O.R. 190, Pg. 741, Tract II), S 28°-15'-07" E, a distance of 538.56 feet to a 5/8 inch iron rod set.

THENCE, with the east line of the said 6.03 acre tract, N 44°-33'-31" E, a distance of 55.25 feet to a 5/8 inch iron rod set.

THENCE, with the southwesterly line of the Gary D. Young original 10.550 acre tract (O.R. 171, Pg. 205), S 32°-15'-35" E, a distance of 893.45 feet to a 5/8 inch iron rod set.

THENCE, with the southwesterly line of the Scott Armentrout 1.000 acre tract (O.R. 187, Pg. 207), S 39°-33'-54" E, a distance of 278.61 feet to a 3/4 inch iron rod found.

THENCE, with the east line of Virginia Military Survey 3137 and the west line of the Thomas L. Wiley 13.344 acre tract (O.R., 403, Pg. 894), S 21°-20'-30" W, a distance of 520.47 feet to a 3/4 inch iron rod found.

THENCE, with the lines of the State of Ohio 3.226 acre tract (O.R. 254, Pg. 95) the following six courses:

N 75°-08'-40" W, a distance of 116.56 feet to a 3/4 inch iron rod found.

N 73°-24'-24" W, a distance of 500.41 feet to a 3/4 inch iron rod found.

S 14°-48'-11" W, a distance of 13.19 feet to a 5/8 inch iron rod set.

S 16°-36'-46" W, a distance of 216.65 feet to a 3/4 inch iron rod found.

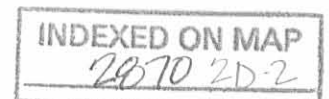

Lee Surveying and Mapping Co., Inc.

Land Surveys • Topography • Subdivisions • Construction Layout

117 N. Madriver St.
Bellefontaine OH 43311



Phone: (937) 593-7335
Fax: (937) 593-7444

S 73°-22'-38" E, a distance of
rod set.

400.15 feet to a 5/8 inch iron

S 71°-03'-10" E, a distance of 196.52 feet to a 5/8 inch iron rod set.

THENCE, with the east line of Virginia Military Survey 3137 and the west lines of the State of Ohio 0.047 acre tract (O.R. 211, Pg. 201) and the Donald L. Van Hyning 77.3 acre tract (O.R. 161, Pg. 204, TractI), S 21°-20'-30" W, a distance of 464.66 feet to the point of beginning.

Containing 182.810 acres of which 16.883 acres are in the highways rights-of-way.

The basis for bearings is the south line of Virginia Military Survey 3137 and the north line of the Michael L. Berry aforementioned 60.69 acre tract being N 70°-10'-10" W, and all other bearings are from angles and distances measured in a field survey by Lee Surveying & Mapping Co., Inc. on December 19, 2003.

Description prepared by:

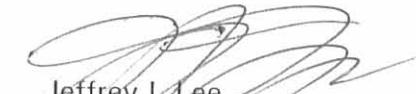

Jeffrey I. Lee
Professional Surveyor 6359
January 13, 2004

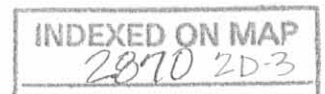

L 3712

1/22/2004

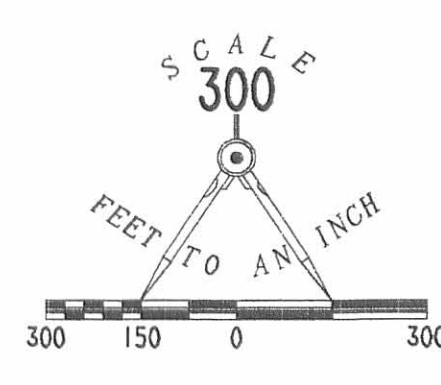



- LEGEND
- 5/8 INCH IRON ROD FOUND
 - 5/8 INCH IRON ROD SET
 - ⊗ 3/4 INCH IRON ROD FOUND
 - 6 INCH X 6 INCH WOOD POST FOUND
 - ⊙ MAG NAIL SET
 - ⊗ RAILROAD SPIKE FOUND
 - 1 INCH IRON PIPE FOUND
 - ⊙ CONCRETE RIGHT-OF-WAY MONUMENT FOUND
 - ⊙ 3" TAPERED SQUARE CONCRETE POST WITH METAL BAR FOUND IN TOP

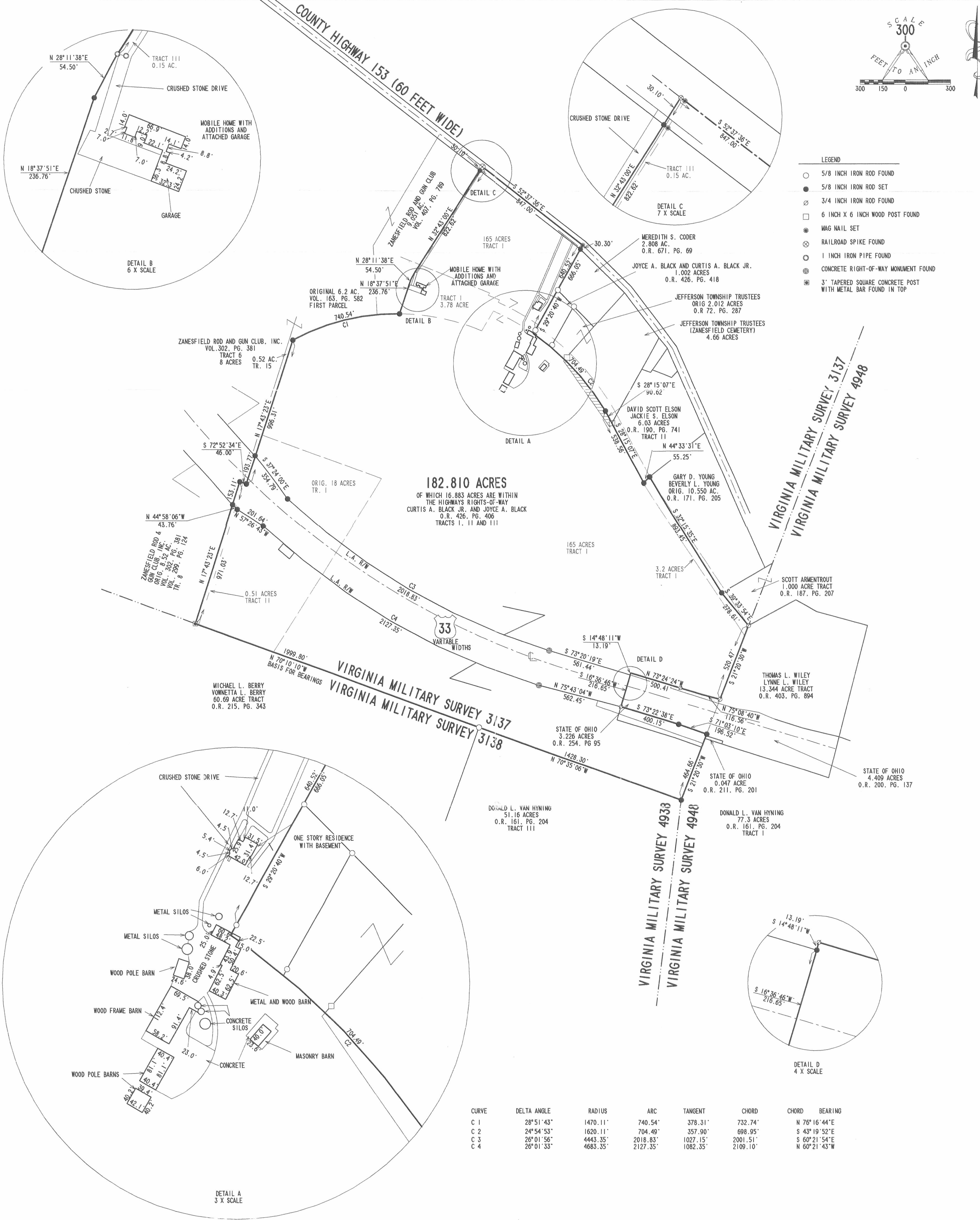

182.810 ACRES
 OF WHICH 16,893 ACRES ARE WITHIN
 THE HIGHWAYS RIGHTS-OF-WAY
 CURTIS A. BLACK JR. AND JOYCE A. BLACK
 O.R. 426, PG. 406
 TRACTS I, II AND III

CURVE	DELTA ANGLE	RADIUS	ARC	TANGENT	CHORD	CHORD BEARING
C 1	28°51'43"	1470.11'	740.54'	378.31'	732.74'	N 76°16'44"E
C 2	24°54'53"	1620.11'	704.49'	357.90'	698.95'	S 43°19'52"E
C 3	26°01'56"	4443.35'	2018.83'	1027.15'	2001.51'	S 60°21'54"E
C 4	26°01'33"	4683.35'	2127.35'	1082.35'	2109.10'	N 60°21'43"W

SURVEY OF THE
 CURTIS A. BLACK JR. AND JOYCE A. BLACK
 OFFICIAL RECORD 356, PAGE 245

TRACT I-THE REMAINDER OF THE 165 ACRE. 3.2 ACRE.
 3.78 ACRE AND THE 18 ACRE TRACTS.

TRACT II-ALL OF THE 0.51 ACRE TRACT

TRACT III-ALL OF THE 0.15 ACRE TRACT

VIRGINIA MILITARY SURVEY 3137
 JEFFERSON TOWNSHIP
 LOGAN COUNTY, OHIO



SURVEYED BY:

 JEFFREY I. LEE
 PROFESSIONAL SURVEYOR 6359
 DECEMBER 19, 2003

COPYRIGHT 2004 BY:
 LEE SURVEYING & MAPPING CO., INC.
 117 North Medriver Street
 BELLEFONTAINE, OHIO 45311
 (937) 593-7335

2 WORKING DAYS
BEFORE YOU DIG
 CALL TOLL FREE 800-362-2764
 OHIO UTILITIES PROTECTION SERVICE.

INDEXED ON MAP
 2870 2P

ORIGINAL STAMP IN GREEN

ADW D411 CBLACK L-3712-1

REC'D 6-23-04 SWM CL

Lee Surveying and Mapping Co., Inc.

Land Surveys • Topography • Subdivisions • Construction Layout

117 N. Madriver St.
Bellefontaine OH 43311

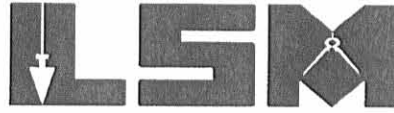

Phone: (937) 593-7335
Fax: (937) 593-7444

ZANESFIELD ROD AND GUN CLUB, INC. 20 FEET WIDE INGRESS/EGRESS AND MAINTENANCE EASEMENT FOR SEPTIC TANK

Lying in Virginia Military Survey 3137, Jefferson Township, Logan County, Ohio.

Being a 20 feet wide ingress/egress and maintenance easement for a septic tank located on the Zanesfield Rod and Gun Club, Inc., 182.810 acre tract as deeded and described in Official Record 704, Page 966, Tract I of the Logan County Records of Deeds and being more particularly described as follows:

Beginning at a railroad spike found on the center-line of County Highway 153 at the northeast corner of the Zanesfield Rod and Gun Club 9.051 acre tract (Vol. 407, Pg. 789).

THENCE, with the center-line of County Highway 153 (60 feet wide), S 52°-37'-36"E, a distance of 675.80 feet to a MAG nail set.

THENCE, S 23°-48'-40"W, a distance of 504.22 feet to a point at the TRUE POINT OF BEGINNING, passing a 5/8 inch iron rod set at 30.86 feet.

THENCE, S 23°-48'-40"W, a distance of 186.84 feet to a 5/8 inch iron rod set.

THENCE, N 66°-11'-20"W, a distance of 20.00 feet to a point.

THENCE, N 23°-48'-40"E, a distance of 186.84 feet to a point.

THENCE, S 66°-11'-20"E, a distance of 20.00 feet to the point of beginning.

The basis for bearings is the south line of Virginia Military Survey 3137 being N 70°-10'-10"W, and all other bearings are from angles and distances measured in a field survey by Lee Surveying and Mapping Co., Inc. on June 18, 2004.

Description prepared by:



ORIGINAL STAMP IN GREEN

Jeffrey I. Lee
Jeffrey I. Lee
Professional Surveyor 6359
June 21, 2004

L-3712

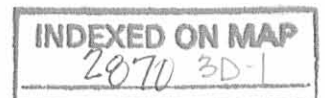

Lee Surveying and Mapping Co., Inc.

Land Surveys • Topography • Subdivisions • Construction Layout

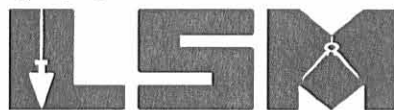

117 N. Madriver St.
Bellefontaine OH 43311

Phone: (937) 593-7335
Fax: (937) 593-7444

ZANESFIELD ROD AND GUN CLUB, INC. 24 FEET WIDE INGRESS/EGRESS EASEMENT

Lying in Virginia Military Survey 3137, Jefferson Township, Logan County, Ohio.

Being a 24 feet wide ingress/egress easement over the Zanesfield Rod and Gun Club, Inc., 182.810 acre tract as deeded and described in Official Record 704, Page 966, Tract I of the Logan County Records of Deeds and being more particularly described as follows:

Beginning at a railroad spike found on the center-line of County Highway 153 at the northeast corner of the Zanesfield Rod and Gun Club 9.051 acre tract (Vol. 407, Pg. 789).

THENCE, with the center-line of County Highway 153 (60 feet wide), S 52°-37'-36"E, a distance of 675.80 feet to a MAG nail set.

THENCE, S 23°-48'-40"W, a distance of 691.06 feet to a point at the TRUE POINT OF BEGINNING, passing a 5/8 inch iron rod set at 30.86 feet.

THENCE, with the center-line of this easement the following five courses:

S 66°-11'-20"E, a distance of 23.65 feet to a point.

S 03°-49'-33"W, a distance of 29.16 feet to a point.

S 1°-58'-11"W, a distance of 75.15 feet to a point.

S 18°-26'-46"W, a distance of 54.12 feet to a point.

N 71°-33'-12"W, a distance of 69.34 feet to a point at the terminus of this easement. Said point is referenced by a 5/8 inch iron rod set S 24°-45'-23"W, a distance of 270.59 feet and a 5/8 inch iron rod set N 24°-45'-23"E, a distance of 145.54 feet.

The basis for bearings is the south line of Virginia Military Survey 3137 being N 70°-10'-10"W, and all other bearings are from angles and distances measured in a field survey by Lee Surveying and Mapping Co., Inc. on June 18, 2004.

Description prepared by:



ORIGINAL STAMP IN GREEN

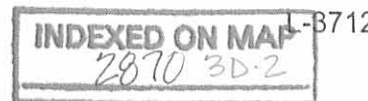

Jeffrey I. Lee
Professional Surveyor 6359
June 21, 2004



LEGEND

- 5/8 INCH IRON ROD SET
- ⊙ MAG NAIL SET
- ⊗ RAILROAD SPIKE FOUND

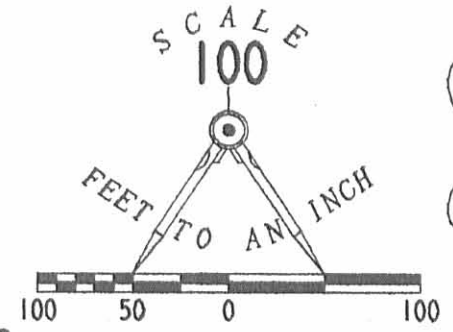
ZANESFIELD ROD AND GUN CLUB
 9.051 ACRES
 VOL. 407. PG. 789



COUNTY HIGHWAY 153 (60')
 S 52° 37' 36" E
 675.80'
 30.86'

ZANESFIELD ROD AND GUN CLUB, INC.
 182.810 ACRES
 O.R. 704. PG. 966
 TRACT I

MEREDITH S. CODER
 2.808 ACRES
 O.R. 671, PG. 69

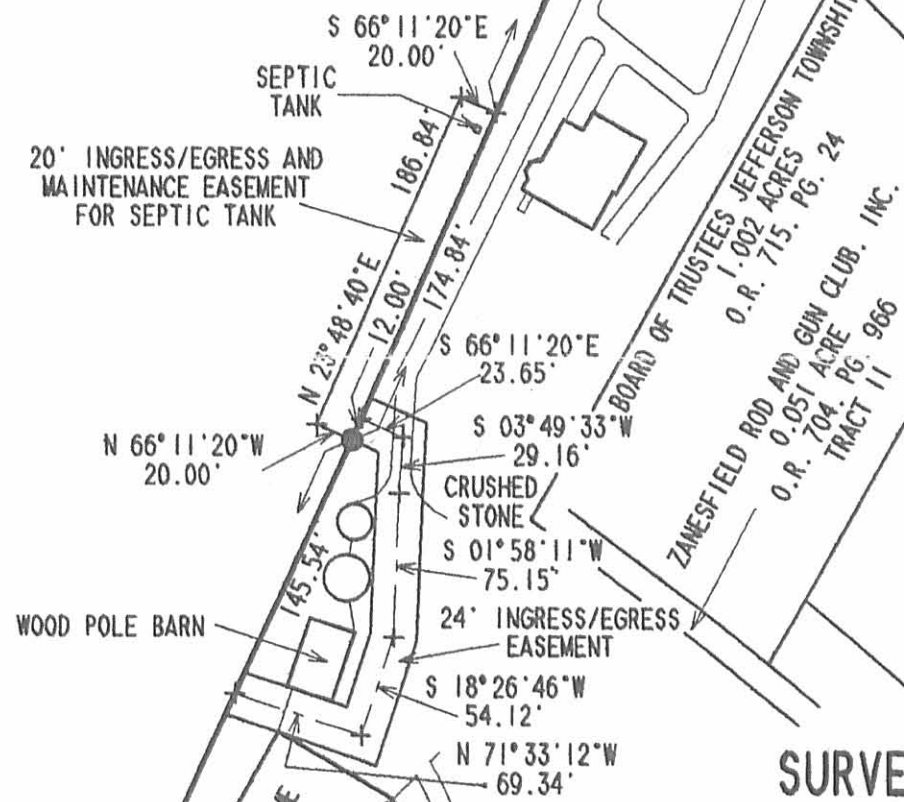

**SURVEY OF A 24 FEET WIDE
 INGRESS/EGRESS EASEMENT
 AND A 20 FEET WIDE
 INGRESS/EGRESS EASEMENT OVER THE
 ZANESFIELD ROD AND GUN CLUB, INC.
 182.810 ACRE TRACT
 OFFICIAL RECORD 704, PAGE 966
 TRACT I
 VIRGINIA MILITARY SURVEY 3137
 JEFFERSON TOWNSHIP
 LOGAN COUNTY, OHIO**

ZANESFIELD ROD AND GUN CLUB, INC.
 182.810 ACRES
 O.R. 704, PG. 966
 TRACT I

SURVEYED BY:

JEFFREY I. LEE
 PROFESSIONAL SURVEYOR 6359
 JUNE 18, 2004

INDEXED ON MAP
 2070 3P



ORIGINAL STAMP IN GREEN

COPYRIGHT 2004 BY:
LEE SURVEYING & MAPPING CO., INC.
 117 North Madriver Street
 BELLEFONTAINE, OHIO 43311
 (937) 593-7335

2 WORKING DAYS
BEFORE YOU DIG
 CALL TOLL FREE **800-362-2764**
 OHIO UTILITIES PROTECTION SERVICE.

BASIS FOR BEARINGS IS THE SOUTH LINE
 OF VIRGINIA MILITARY SURVEY 3137
 BEING N 70° 10' 10" W

KSR D412 3712064 L-3712-3

Lee Surveying and Mapping Co., Inc.

Land Surveys • Topography • Subdivisions • Construction Layout

117 N. Madriver St.
Bellefontaine OH 43311



Phone: (937) 593-7335
Fax: (937) 593-7444

ZANESFIELD ROD AND GUN CLUB INC. 69.756 ACRE TRACT

Lying in Virginia Military Survey 3137, Jefferson Township, Logan County, Ohio

Being out of the Zanesfield Rod and Gun Club, Inc., 182.810 acre tract as deeded and described in Official Record 704, Page 966, Tract I of the Logan County Records of Deeds and being more particularly described as follows:

Beginning at a railroad spike found on the center-line of County Highway 153 (60 feet wide), and at the northeast corner of the Zanesfield Rod and Gun Club 9.051 acre tract (Vol. 407, Pg. 789).

THENCE, with the center line of County Highway 153, S 52°-37'-36"E, a distance of 675.80 feet to a MAG nail set at the TRUE POINT OF BEGINNING.

THENCE, with the center-line of County Road 153 (60 feet wide), S 52°-37'-36"E, a distance 171.20 feet to a MAG nail found.

THENCE, with the west line of the Meredith S. Coder 2.808 acre tract (O.R. 671, Pg. 69) and the Board of Trustees of Jefferson Township 1.002 acre tract (O.R. 715, Pg. 24) and the Zanesfield Rod and Gun Club Inc. 0.051 acre tract (O.R. 704, Pg. 966, Tract II), S 29°-20'-40" W, a distance of 666.05 feet to a point, passing a 5/8 inch iron rod found at 30.30 feet and a 5/8 inch iron rod found at 640.52 feet.

THENCE, with the south line of the said 0.051 acre tract and the south line of the Trustees of Jefferson Township 0.741 acre tract (O.R. 713, Pg. 700), with a curve to the right having a central angle of 24°-54'-53", an arc length of 704.49 feet, a radius of 1620.11 feet and a chord bearing S 43°-19'-52" E, a distance of 698.95 feet to a 5/8 inch iron rod found.

THENCE, continuing with the south line of the said 0.741 acre tract and the David Scott Elson 0.526 acre tract (O.R. 704, Pg. 989), S 28°-15'-07" E, a distance of 538.56 feet to a 5/8 inch iron rod found.

THENCE, with the east line of the said 0.526 acre tract, N 44°-33'-31" E, a distance of 55.25 feet to a 5/8 inch iron rod found.

THENCE, with the southwesterly line of the Gary D. Young original 10.550 acre tract (O.R. 171, Pg. 205), S 32°-15'-35" E, a distance of 893.45 feet to a 5/8 inch iron rod found.

THENCE, with the southwesterly line of the Scott Armentrout 1.000 acre tract (O.R. 187, Pg. 207), S 39°-33'-54" E, a distance of 278.61 feet to a 3/4 inch iron rod found.

THENCE, with the east line of Virginia Military Survey 3137 and the west line of the Thomas L. Wiley 13.344 acre tract (O.R., 403, Pg. 894), S 21°-20'-30" W, a distance of 520.47 feet to a 3/4 inch iron rod found.

THENCE, with the lines of the State of Ohio 3.226 acre tract (O.R. 254, Pg. 95) the following three courses:

N 75°-08'-40" W, a distance of 116.56 feet to a 3/4 inch iron rod found.

N 73°-24'-24" W, a distance of 500.41 feet to a 3/4 inch iron rod found.

S 14°-48'-11" W, a distance of 13.19 feet to a 5/8 inch iron rod found.

THENCE, with the north right-of-way of U.S. 33, N 73°-20'-19"W, a distance of 561.44 feet to a concrete right-of-way monument found.

Lee Surveying and Mapping Co., Inc.

Land Surveys • Topography • Subdivisions • Construction Layout

117 N. Madriver St.
Bellefontaine OH 43311



Phone: (937) 593-7335
Fax: (937) 593-7444

THENCE, with the north right-of-way of U.S. 33, with a curve to the right having a central angle of $16^{\circ}-46'-12''$, a radius of 4443.35 feet, an arc length of 1300.53 feet, a chord bearing N $64^{\circ}-59'-47''$ W, a distance of 1295.89 feet to a 5/8 inch iron rod set.

THENCE, N $47^{\circ}-47'-53''$ E, a distance of 621.18 feet to a 5/8 inch iron rod set.

THENCE, N $30^{\circ}-05'-30''$ E, a distance of 353.80 feet to a 5/8 inch iron rod set.

THENCE, N $70^{\circ}-31'-26''$ W, a distance of 72.29 feet to a 5/8 inch iron rod set.

THENCE, N $27^{\circ}-32'-55''$ E, a distance of 502.71 feet to a 5/8 inch iron rod set.

THENCE, N $24^{\circ}-45'-23''$ E, a distance of 416.13 feet to a 5/8 inch iron rod set.

THENCE, N $23^{\circ}-48'-40''$ E, a distance of 703.06 feet to the point of beginning, passing a 5/8 inch iron rod set at 672.20 feet

Containing 69.756 acres of which 0.117 acre is in the highway right-of-way.

The basis for bearings is the south line of Virginia Military Survey 3137 being N $70^{\circ}-10'-10''$ W, and all other bearings are from angles and distances measured in a field survey by Lee Surveying & Mapping Co., Inc. on December 19, 2003 and June 3, 2004



ORIGINAL STAMP IN GREEN

Description prepared by:

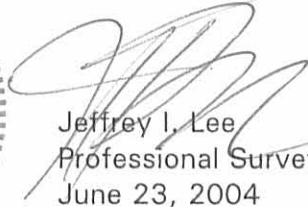
Jeffrey I. Lee
Professional Surveyor 6359
June 23, 2004

L-3712

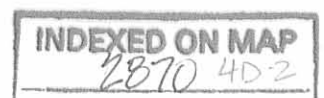

Lee Surveying and Mapping Co., Inc.

Land Surveys • Topography • Subdivisions • Construction Layout

117 N. Madriver St.
Bellefontaine OH 43311

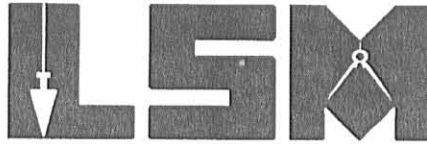

Phone: (937) 593-7335
Fax: (937) 593-7444

ZANESFIELD ROD AND GUN CLUB INC., 113.054 ACRE TRACT

Lying in Virginia Military Survey 3137, Jefferson Township, Logan County, Ohio

Being out of the Zanesfield Rod and Gun Club, Inc., 182.810 acre tract as deeded and described in Official Record 704, Page 966, Tract I of the Logan County Records of Deeds and being more particularly described as follows:

Beginning at a railroad spike found on the center-line of County Highway 153 (60 feet wide), and at the northeast corner of the Zanesfield Rod and Gun Club 9.051 acre tract (Vol. 407, Pg. 789).

THENCE, with the center line of County Highway 153, S 52°-37'-36"E, a distance of 675.80 feet to a MAG nail set.

THENCE, S 23°-48'-40"W a distance of 703.06 feet to a 5/8 inch iron rod set, passing a 5/8 inch iron rod set at 30.86 feet.

THENCE, S 24°-45'-23"W, a distance of 416.13 feet to a 5/8 inch iron rod set.

THENCE, S 27°-32'-55"W, a distance of 502.71 feet to a 5/8 inch iron rod set.

THENCE, S 70°-31'-26"E, a distance of 72.29 feet to a 5/8 inch iron rod set.

THENCE, S 30°-05'-30"W, a distance of 353.80 feet to a 5/8 inch iron rod set.

THENCE, S 47°-47'-53"W, a distance of 621.18 feet to a 5/8 inch iron rod set.

THENCE, with the north right-of-way of U.S. Highway 33 with a curve to the left having a central angle of 16°-46'-12", a radius of 4443.35 feet, an arc length of 1300.53 feet, a chord bearing S 64°-59'-47"E, a distance of 1295.89 feet to a concrete right-of-way monument found.

THENCE, with the north right-of-way of U.S. Highway 33, S 73°-20'-19"E, a distance of 561.44 feet to a 5/8 inch iron rod found.

THENCE, with the lines of the State of Ohio 3.226 acre tract (O.R. 254, Pg. 95), the following three courses:

S 16°-36'-46"W, a distance of 216.65 feet to a 3/4 inch iron rod found.

S 73°-22'-38"E, a distance of 400.15 feet to a 5/8 inch iron rod found.

S 71°-03'-10"E, a distance of 196.52 feet to a 5/8 inch iron rod found.

THENCE, with the east line of Virginia Military Survey 3137 and the west line of the State of Ohio 0.047 acre tract (O.R. 211, Pg. 201) and the Donald L. Van Hyning 77.3 acre tract (O.R. 161, Pg. 204, Tract I), S 21°-20'-30"W, a distance of 464.66 feet to a 5/8 inch iron rod found.

THENCE, with the south line of Virginia Military Survey 3137 the following two courses:

With the north line of the Donald L. Van Hyning 51.16 acre tract (O.R. 161, Pg. 204 Tract III), N 70°-35'-06" W, a distance of 1428.30 feet to a 5/8 inch iron rod found.

With the north line of the Michael L. Berry 60.69 acre tract (O.R. 215, Pg. 343), N 70°-10'-10"W, a distance of 1999.80 feet to a 3' tapered square concrete post with a metal bar found in top.

Lee Surveying and Mapping Co., Inc.

Land Surveys • Topography • Subdivisions • Construction Layout

117 N. Madriver St.
Bellefontaine OH 43311



Phone: (937) 593-7335
Fax: (937) 593-7444

THENCE, with the east line of the Zanesfield Rod and Gun Club, Inc. original 8.52 acre tract (Vol. 302, Pg. 381 and Vol. 299, Pg. 124, Tract 8), N 17°-43'-23" E, a distance of 971.03 feet to a 5/8 inch iron rod found, passing a 5/8 inch iron rod found at 817.92 feet.

THENCE, with the said 8.52 acre tract and the Zanesfield Rod and Gun Club, Inc. 0.52 acre tract (Vol. 302, Page 381, Tract 15), S 72°-52'-34"E, a distance of 46.00 feet to a 5/8 inch iron rod found.

THENCE, with the east line of the said 0.52 acre tract, N 17°-43'-23" E, a distance of 996.31 feet to a 5/8 inch iron rod found.

THENCE, with the southerly lines of the Zanesfield Rod and Gun Club, Inc. original 6.2 acre tract (Vol. 163, Pg. 582 first parcel) and the said 9.051 acre tract with a curve to the right having a central angle of 28°-51'-43", a radius of 1470.11 feet, an arc distance of 740.54 feet, and having a chord bearing N 76°-16'-44" E, a distance of 732.74 feet to a 5/8 inch iron rod found.

THENCE, with the east lines of the said 9.051 acre tract the following three courses:

N 18°-37'-51" E, a distance of 236.76 feet to a 5/8 inch iron rod found.

N 28°-11'-38" E, a distance of 54.50 feet to a 1 inch iron pipe found.

N 32°-43'-00" E, a distance of 822.62 feet to the point of beginning, passing a 5/8 inch iron rod found at 792.52 feet.

Containing 113.054 acres of which 16.766 acres are in the highway rights-of-way.

The basis for bearings is the south line of Virginia Military Survey 3137 being N 70°-10'-10" W, and all other bearings are from angles and distances measured in a field survey by Lee Surveying & Mapping Co., Inc. on December 19, 2003 and June 3, 2004.



ORIGINAL STAMP IN GREEN

Description prepared by:

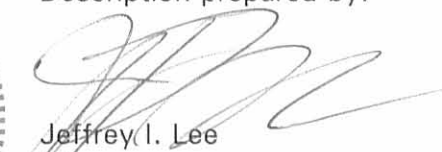

Jeffrey I. Lee
Professional Surveyor 6359
June 23, 2004

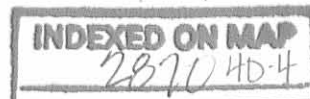
L-3712

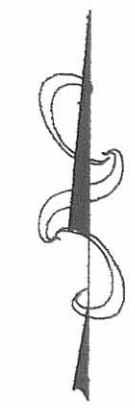
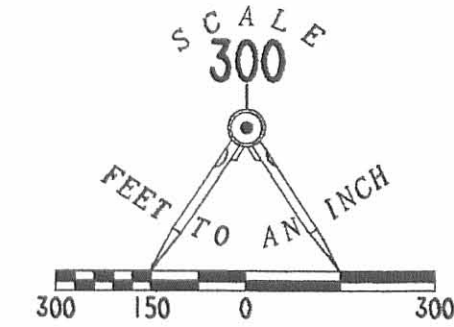

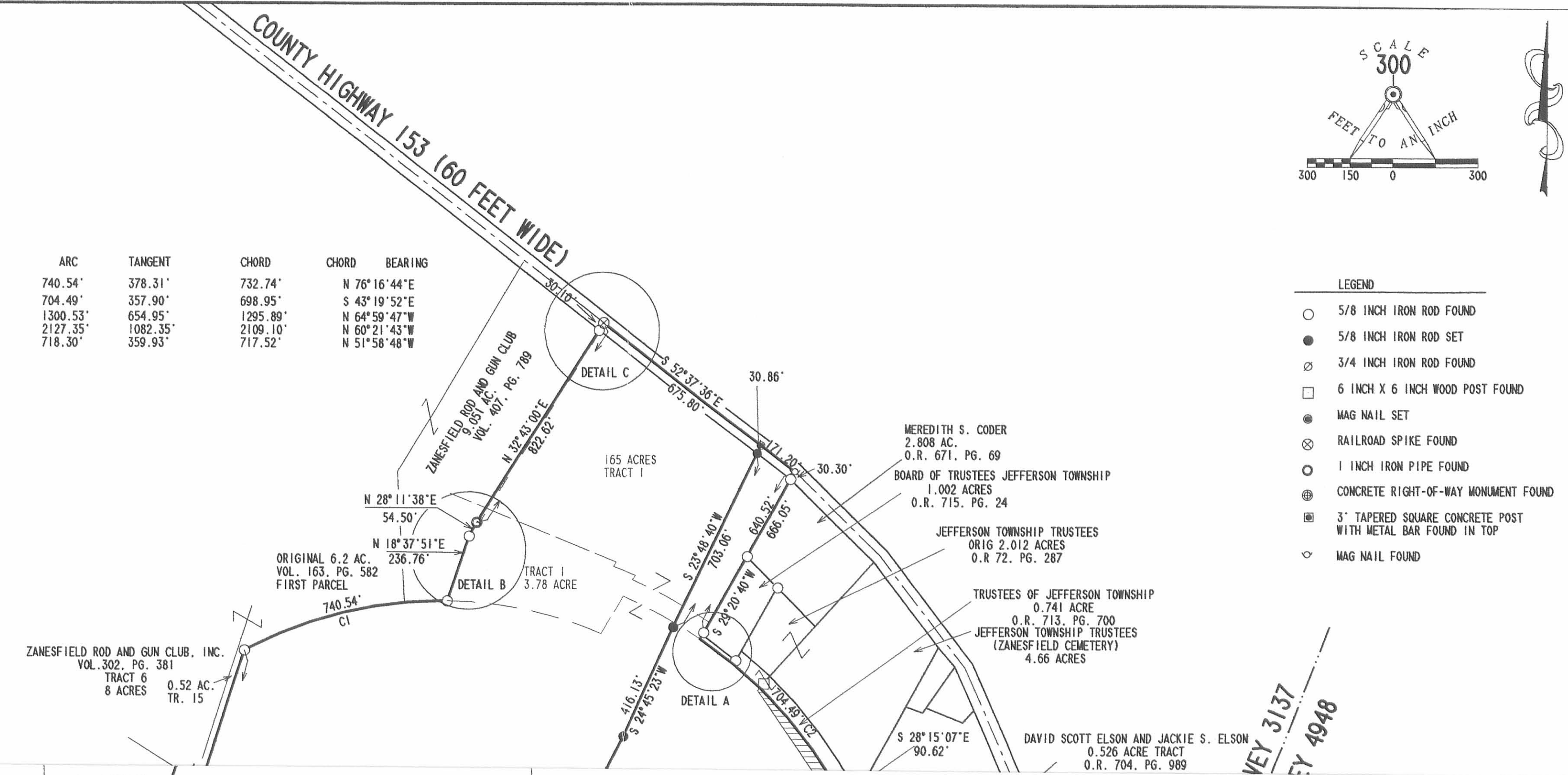

CURVE	DELTA ANGLE	RADIUS	ARC	TANGENT	CHORD	CHORD BEARING
C 1	28° 51' 43"	1470.11'	740.54'	378.31'	732.74'	N 76° 16' 44" E
C 2	24° 54' 53"	1620.11'	704.49'	357.90'	698.95'	S 43° 19' 52" E
C 3	16° 46' 12"	4443.35'	1300.53'	654.95'	1295.89'	N 64° 59' 47" W
C 4	26° 01' 33"	4683.35'	2127.35'	1082.35'	2109.10'	N 60° 21' 43" W
C 5	9° 15' 44"	4443.35'	718.30'	359.93'	717.52'	N 51° 58' 48" W



- LEGEND
- 5/8 INCH IRON ROD FOUND
 - 5/8 INCH IRON ROD SET
 - ⊗ 3/4 INCH IRON ROD FOUND
 - 6 INCH X 6 INCH WOOD POST FOUND
 - MAG NAIL SET
 - ⊗ RAILROAD SPIKE FOUND
 - 1 INCH IRON PIPE FOUND
 - ⊗ CONCRETE RIGHT-OF-WAY MONUMENT FOUND
 - 3' TAPERED SQUARE CONCRETE POST WITH METAL BAR FOUND IN TOP
 - ◇ MAG NAIL FOUND

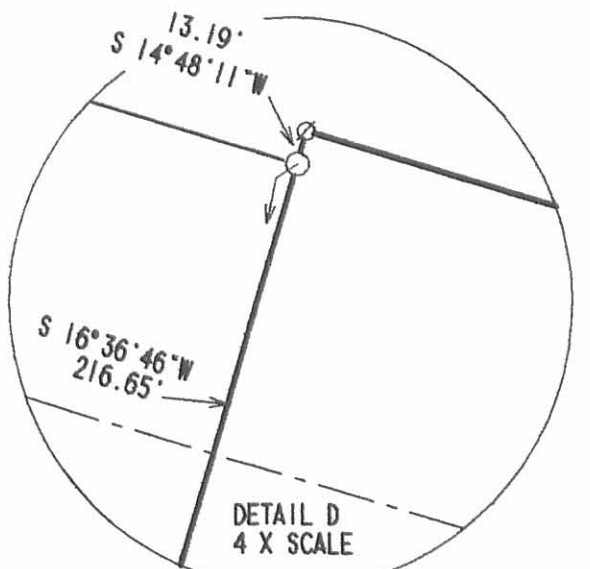
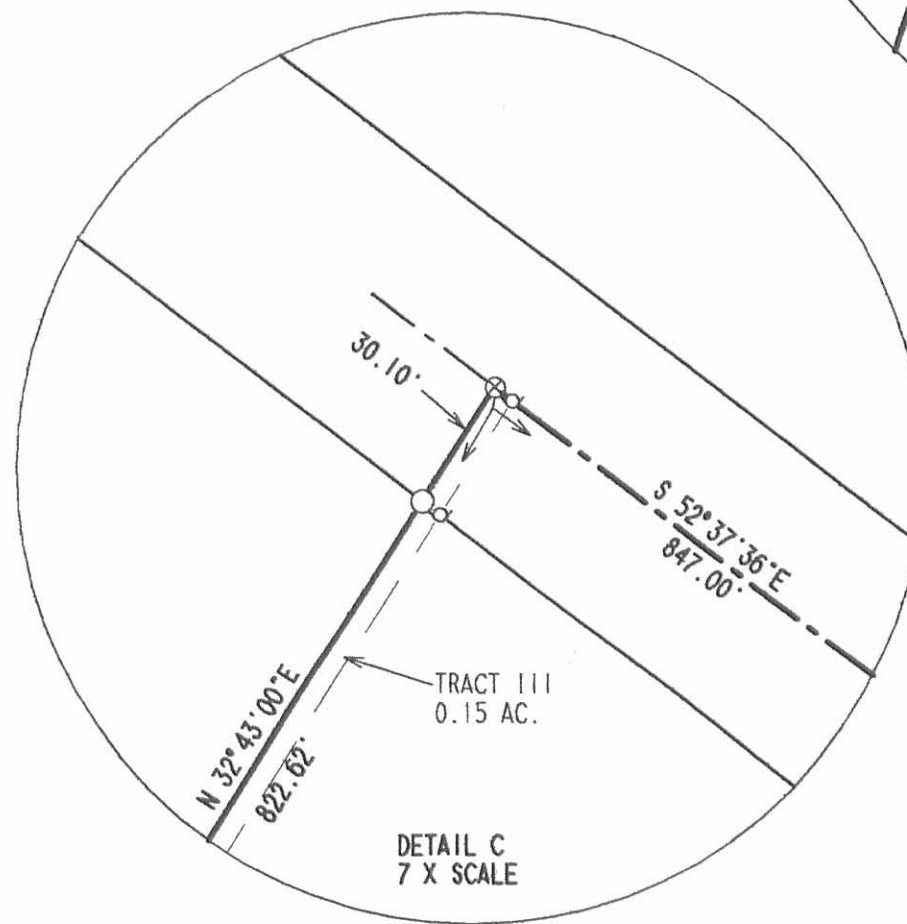
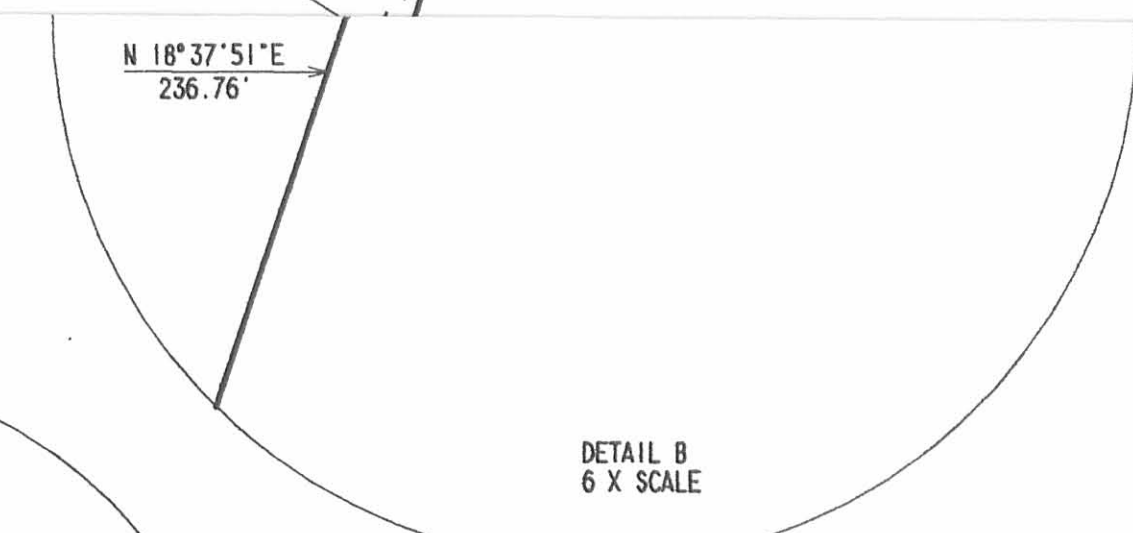

**SURVEY OF A 69.756 ACRE TRACT AND
A 113.055 ACRE TRACT OUT OF THE
ZANESFIELD ROD AND GUN CLUB INC.
182.810 ACRE TRACT
OFFICIAL RECORD 704, PAGE 966, TRACT 1
VIRGINIA MILITARY SURVEY 3137
JEFFERSON TOWNSHIP
LOGAN COUNTY, OHIO**

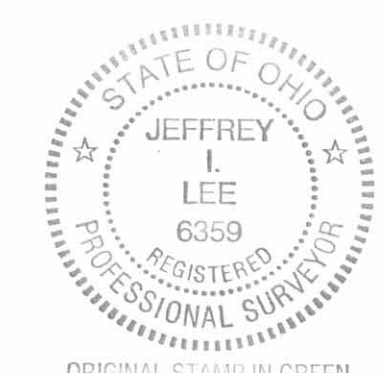

SURVEYED BY:
[Signature]
JEFFREY I. LEE
PROFESSIONAL SURVEYOR 6359
JUNE 3, 2004

INDEXED ON MAP
2070 HP

COPYRIGHT 2004 BY:
LEE SURVEYING & MAPPING CO., INC.
117 North Madriver Street
BELLEFONTAINE, OHIO 43311
(937) 593-7335

2 WORKING DAYS
BEFORE YOU DIG
CALL TOLL FREE **800-362-2764**
OHIO UTILITIES PROTECTION SERVICE.

Cushman - Black Survey Jefferson Township April 1958 1.72 Acres.

The following described land in Jefferson Township, Logan County, Ohio,
and being in V.M.S. 3137

Being 1.72 acres off of the west side of Curtis Black's present 4.02
acre tract the 1.72 acre tract being more fully described as follows :

Beginning at the N.E. corner of Warren Cushman's present 5.80 acre tract
in the center of State Highway Number 235 (U.S. Route Number 33) and
in the center of the (Abandoned) Depot Pike thence with the center of
said Depot Pike S. 34 - 30 W. 820.0 feet to an iron at an angle in
said Pike thence with the center of said Depot Pike N. 73 - 10 W.
10.9 feet to an iron said iron being the beginning point of this survey
thence with the present fence line S. 28 - 19 W. 104.6 feet to a
wood post thence again with the present fence S. 18 - 58 W. 191.0 feet
to a large round wood post thence N. 88 - 23 W. 73.0 feet to an iron
thence S. 88-42 W. 100.0 feet to a large square wood post at the S.W.
corner of said Black's 4.02 acre tract the last two described lines
being with the present fence line at the south side of what was formerly
the T.&.O.C. Right of Way thence with the present fence line at the
west side of Said Black's present 4.02 acre tract N. 1 - 47 W. 364.0
feet to an iron in the center ~~of~~ line of said Depot Pike thence with the
center line of said Depot Pike S. 73 - 10 E. 308.7 feet to the place
of beginning said described tract containing 1.72 acres.

cc
Logan County Engineer

*On plat
after Johnson*

2870 5D-1

Cushman - Black Survey Jefferson Township April 1958 0.15 Acre

The following described land in Jefferson Township, Logan County Ohio,
and being in V.M.S. 3137

Being 0.15 Of one acre off of the east side of Warren Cushman's
present 5.80 acre tract and being a strip of land between the center
line of the Depot Pike and the present fence the 0.15 acre tract
being more fully described as follows,

Beginning at the N.E. corner of said Cushman's present 5.80 acre tract
in the center of State Highway Number 235 (U.S.Route Number 33)
and in the center of the (Abandoned) Depot Pike thence with the
west side of the Curtis Black land and with the center ~~of~~ line of
said Depot Pike S. 34 - 30 W. 820.0 feet to an iron ~~pin~~ at an
angle in said Depot Pike thence again with the center of said Depot
Pike N. 73 - 10 W. 10.9 feet to an iron thence with the present fence
line N. 34 - 53 E. 823.3 feet to the center of said U.S.Route Number 33
thence with the center of said U.S.Route Number 33 S. 45 - 30 E.
5.0 feet to the place of beginning said described tract containing 0.15
of one acre.

cc
Logan County Engineer

2870 5D-2

5.80
- 5.65

0.15

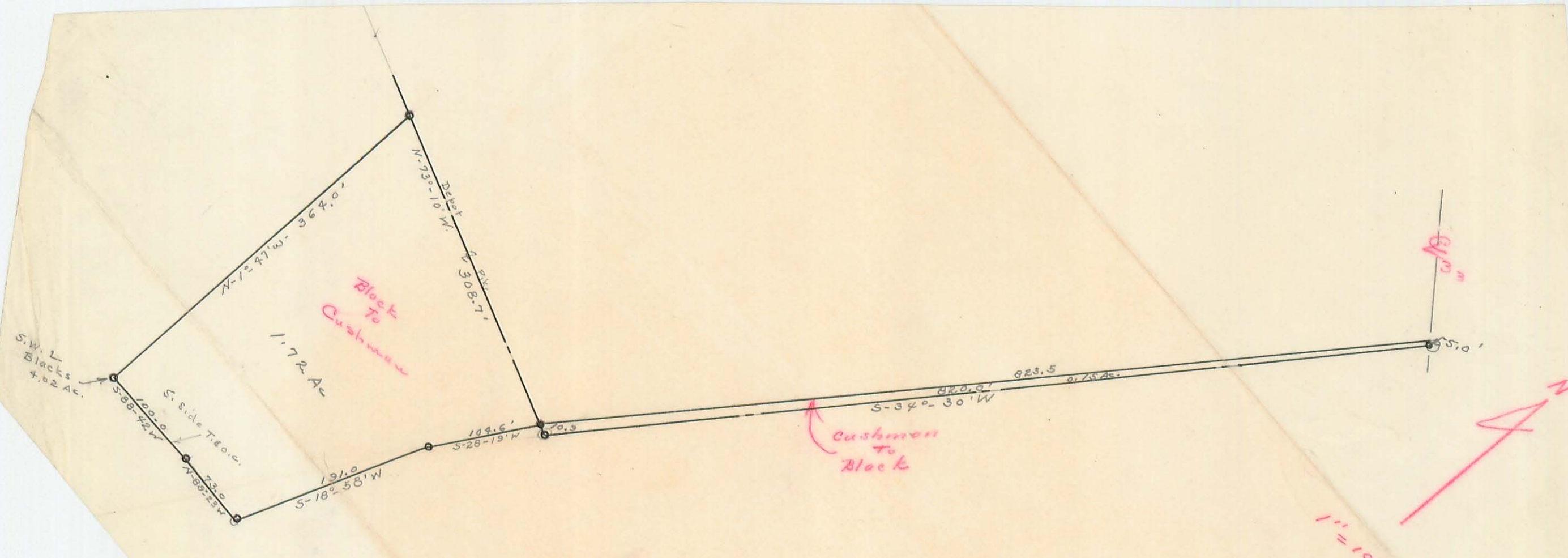

S.W. L
Blacks
4.02 Ac.

S. Side T. & C. & C.

Block
To
Cushman

1.72 Ac.

Cushman
To
Block

61.0'

1" = 100'

Surveyed May 1958

INDEXED ON MAP
28004 5D

308.7
364.0
104.6
191.0
73.0
100.0
820.9