

## NOTICE FOR BIDS

Notice is hereby given that bids will be received at the office of the Logan County Commissioners, 117 E. Columbus Avenue, Suite 100, Bellefontaine, Ohio on **Tuesday, February 11, 2014 at 9:30 AM**, Ohio Standard Time for the purpose of furnishing PRECAST CONCRETE BOX CULVERT SECTIONS, PRECAST WINGWALLS AND RELATED MATERIAL according to specifications on file in the Logan County Engineers Office.

Bids shall be submitted on forms furnished by the Logan County Engineer (1991 CR 13, Bellefontaine, Ohio, 43311, 937-592-2791) in a sealed envelope marked **"Precast Concrete Box Culvert Bid for Bridge 34-4.78"** on the outside.

Bids will be for the furnishing, delivering and setting in place precast concrete box culvert sections and precast wingwalls.

As specified in R.C. 153.54, a bidder must submit a bid guaranty in the form of either:

- (1) a bond for the full amount of the bid, or
- (2) a certified check, cashier's check, or letter of credit in the amount of 10% of the bid.

Bidders shall comply with the provisions of the Americans with Disabilities Act of 1990.

**"Domestic steel use requirements as specified in section 153.011 of the Revised Code apply to this project. Copies of section 153.011 of the Revised Code can be obtained from any of the offices of the department of administrative services."**

Bids will be accepted only from fabricators who are pre-qualified with the State of Ohio as producers of Item 706.05, Precast Reinforced Concrete Box Sections at the time of the award.

Bids will be awarded to the lowest and best bidder.

The Board of Commissioners reserves the right to reject any or all bids and to waive any defects in the bids.

The Notice to Bidders is posted on the Internet and may be viewed on Logan County Engineer's web page at: [http://www.co.logan.oh.us/engineer/Bid\\_Documents/index.html](http://www.co.logan.oh.us/engineer/Bid_Documents/index.html)

By Order of the Board of  
Logan County Commissioners

Kacy D. Kirby, Clerk/Administrator

Posted: January 28, 2014

Advertised: January 28, 2014

**LOGAN COUNTY COMMISSIONERS  
 PRECAST CONCRETE BOX CULVERT SECTIONS, PRECAST WINGWALLS AND  
 RELATED MATERIAL**

**BID FORM - PRECAST OPTION**

Gentlemen:

The undersigned, having full knowledge of the site, plans and specifications for the following structures, and the conditions of the bid, hereby agrees to furnish to the Commissioners of Logan County all services, labor, materials and equipment necessary to provide precast concrete box culvert sections and wingwalls set in place on aggregate bedding prepared by Logan County, according to the plans and specifications, and to accept the total price specified below as full compensation for the work on this project.

Related material is to include joint sealant and joint wrap (Conseal 212 or approved equivalent) w/ primer, and Ipanex (or approved equal) in the concrete at the rate of 13.8 oz. per 100 lbs. of cement as a concrete densifier.

**Note: Precast wingwalls may be non-performed at the time of award depending on bid price and/or Logan County crew scheduling. The bidder is expected to honor the box culvert bid price as the total bid amount in this instance.**

<i>LOG BR 34-4.78</i>	<i>BID PRICE</i>	<i>INSTALLATION DATE</i>
BOX CULVERT	\$	
WINGWALLS	\$	
<b>TOTAL BID AMOUNT</b>	\$	

Grand Total Bid (written): \_\_\_\_\_  
 \_\_\_\_\_  
 \_\_\_\_\_

Respectfully submitted,

\_\_\_\_\_  
 Company or Individual

\_\_\_\_\_  
 Address

By \_\_\_\_\_

Title \_\_\_\_\_

Phone No. \_\_\_\_\_

Bid Date: February 11, 2014 at 9:30 A.M.

**LOGAN COUNTY COMMISSIONERS  
 PRECAST CONCRETE BOX CULVERT SECTIONS, PRECAST WINGWALLS AND  
 RELATED MATERIAL**

**BID FORM - CAST IN PLACE OPTION**

Gentlemen:

The undersigned, having full knowledge of the site, plans and specifications for the following structures, and the conditions of the bid, hereby agrees to furnish to the Commissioners of Logan County all services, labor, materials and equipment necessary to provide precast concrete box culvert sections and wingwalls set in place on aggregate bedding prepared by Logan County, according to the plans and specifications, and to accept the total price specified below as full compensation for the work on this project.

All terms of the PRECAST OPTION shall apply except that the box culvert and wingwalls shall be cast in place on the bridge site, according to a proposal subject to approval by the Logan County Engineer's Office. The proposal shall be submitted with the bid documents and include a closure duration.

<i><b>LOG BR 34-4.78</b></i>	<i><b>BID PRICE</b></i>	<i><b>INSTALLATION DATE</b></i>
BOX CULVERT	\$	
WINGWALLS	\$	
<b>TOTAL BID AMOUNT</b>	<b>\$</b>	

Grand Total Bid (written): \_\_\_\_\_  
 \_\_\_\_\_  
 \_\_\_\_\_

Respectfully submitted,

\_\_\_\_\_  
 Company or Individual

\_\_\_\_\_  
 Address

By \_\_\_\_\_

Title \_\_\_\_\_

Phone No. \_\_\_\_\_

Bid Date: February 11, 2014 at 9:30 A.M.

## GENERAL CONDITIONS

1. The **County** shall be responsible site preparation for the installation of the box culvert sections and wingwalls.
2. The **Contractor** shall be responsible for furnishing, delivering and setting in place the box culvert sections and wingwalls at the bridge site. The Contractor is encouraged to visit the site prior to bidding to determine field conditions.
3. The **Contractor** shall be responsible for design of the concrete box culvert and wingwalls shown in the plans, and shall supply the County with shop drawings stamped by a Registered Professional Engineer in the State of Ohio.
4. The **Contractor** shall submit detailed bridge load rating calculations according to Section 900 of the current ODOT Bridge Design Manual, using load resistance factor rating. The load rating calculations shall be submitted with the shop drawings. Load ratings shall be provided for an HS20-44 truck for inventory and operating levels, as well as the four Ohio Legal Loads (2F1, 3F1, 4F1, and 5C1) at operating level. The contractor shall provide the County with a printed report, stamped by a Registered Professional Engineer in the State of Ohio, as well as input and output files from the software used on cd/dvd.

**OHIO REVISED CODE**  
**SECTION 3517.13**

Ohio Revised Code Section 3517.13 I(3) and J(3) requires that no agency or department of this state or any political subdivision shall enter into any contract for the purchase of goods costing more than ten thousand dollars with a corporation, individual, partnership or other unincorporated business, association, including, without limitation, a professional association organized under Chapter 1785 of the Revised Code, estate, or trust unless the contract includes a certification that the individuals named in Revised Code, estate, or trust unless the contract includes a certification that the individuals named in Revised Code Sections 3517.13 (I)(1) and (J)(1) are in compliance with the aforementioned provisions. The bidder is required to complete the affidavit provided. Failure to submit the required form with the proposal/bid package could deem the bidder's response to be non-responsive and disqualified from receiving further consideration.



- (c) Each child seven years of age to seventeen years of age of an owner of more than twenty percent of the corporation or business trust;
- (d) Any political action committee affiliated with the corporation or business trust;
- (e) Any combination of persons identified in (a) through (d) of this section.

5. I further certify compliance with division (J)(4)(a) of Section 3517.13 of the Ohio Revised Code and that no political action committee that is affiliated with the above-named Corporation/Business Trust has made, within the two previous calendar years, one or more contributions totaling in excess of two thousand dollars to the holder of the public office having ultimate responsibility for the award of the contract or to the public officer's campaign committee, and I understand that the holder of the public office having ultimate responsibility for the award of the contract includes any member of the Board of County Commissioners of Logan County, Ohio.

6. I further certify that, in accordance with division (J) (4) (b) of Section 3517.13 of the Ohio Revised Code, if the above-named Corporation/Business Trust is awarded a contract by the Board of County Commissioners of Logan County, Ohio for the purchase of goods or services costing more than ten thousand dollars, no political action committee that is affiliated with the above-named Corporation/Business trust shall, beginning on the date the contract is awarded and extending until one year following the conclusion of that contract, make one or more contributions totaling in excess of two thousand dollars to the holder of the public office having ultimate responsibility for the award of the contract or to the public officer's campaign committee, and I understand that the holder of the public office having ultimate responsibility for the award of the contract includes any member of the Board of County Commissioners of Logan County, Ohio.

7. I do hereby acknowledge that to knowingly make any false statement herein may subject me and/or the above named Corporation/Business trust to the penalties set forth in section 3517.992 of the Ohio Revised Code.

Further, Affiant sayeth naught.

\_\_\_\_\_  
Signature

\_\_\_\_\_  
Title

Sworn to and subscribed by \_\_\_\_\_ in my presence  
this \_\_\_\_\_ day of \_\_\_\_\_, \_\_\_\_\_.

\_\_\_\_\_  
Notary Public

**AFFIDAVIT IN COMPLIANCE WITH  
SECTION 3517.13 OF THE OHIO REVISED CODE  
(Individuals or Non-Corporate Entities)  
(R.C. 3517.13(1)(3))**

STATE OF OHIO  
COUNTY OF LOGAN

I, the undersigned, after being first duly cautioned and sworn, state the following with respect to Section 3517.13 of the Ohio Revised Code:

1. I am \_\_\_\_\_ and I am employed as  
[Name]  
\_\_\_\_\_ for \_\_\_\_\_  
[Title] [Entity]
  
2. In my position as \_\_\_\_\_, I have the authority  
[Title]  
to make the certifications contained herein on behalf of the above-named Entity.
  
3. On behalf of the above-named Entity, I do hereby certify that the following persons, if applicable, are in compliance with division (I)(1) of Section 3517.13 of the Ohio Revised Code:
  - (a) The individual;
  - (b) Each partner or owner of the partnership or other unincorporated business;
  - (c) Each shareholder of the association;
  - (d) Each administrator of the estate;
  - (e) Each executor of the estate;
  - (f) Each trustee of the trust;
  - (g) Each spouse of any person identified in (a) through (f) of this section;
  - (h) Each child seven years of age to seventeen years of age of any person identified in (a) through (f) of this section;
  - (i) Any political action committee affiliated with the partnership or other unincorporated business, association, estate, or trust.
  - (j) Any combination of persons identified in (a) through (i) of this section.
  
4. I further certify that if the above-named Entity is awarded a contract by the Board of Commissioners of Logan County, Ohio for the purchase of goods or services costing more than ten thousand dollars, the following persons shall, beginning on the date the contract is awarded and extending until one year following the conclusion of that contract, maintain compliance with division (I)(2) of Section 3517.13 of the Ohio Revised Code:
  - (a) The individual;
  - (b) Each partner or owner of the partnership or other unincorporated business;
  - (c) Each shareholder of the association;
  - (d) Each administrator of the estate;
  - (e) Each executor of the estate;
  - (f) Each trustee of the trust;
  - (g) Each spouse of any person identified in (a) through (f) of this section;



- (h) Each child seven years of age to seventeen years of age of any person identified in (a) through (f) of this section;
  - (i) Any political action committee affiliated with the partnership or other unincorporated business, association, estate, or trust.
  - (j) Any combination of persons identified in (a) through (i) of this section.
5. I further certify compliance with division (I)(4)(a) of Section 3517.13 of the Ohio Revised Code and that no political action committee that is affiliated with the above-named Entity has made, within the two previous calendar years, one or more contributions totaling in excess of two thousand dollars to the holder of the public office having ultimate responsibility for the award of the contract or the public officer's campaign committee, and I understand that the holder of the public office having ultimate responsibility for the award of the contract includes any member of the Board of County Commissioners of Logan County, Ohio.
  6. I further certify that, in accordance with division (I)(4)(b) of Section 3517.13 of the Ohio Revised Code, if the above-named Entity is awarded a contract by the Board of County Commissioners of Logan County, Ohio for the purchase of goods or services costing more than ten thousand dollars, no political action committee that is affiliated with the above-named Entity shall, beginning on the date the contract, make one or more contributions totaling in excess of two thousand dollars to the holder of the public office having ultimate responsibility for the award of the contract or to the public officer's campaign committee, and I understand that the holder of the public office having ultimate responsibility for the award of the contract includes any member of the Board of County Commissioners of Logan County, Ohio.
  7. I do hereby acknowledge that to knowingly make any false statement herein may subject me and/or the above-named Entity to the penalties set forth in Section 3517.992 of the Ohio Revised Code.

Further, Affiant sayeth naught.

\_\_\_\_\_  
Signature

\_\_\_\_\_  
Title

Sworn to and subscribed by \_\_\_\_\_ in my presence this  
\_\_\_\_\_ day of \_\_\_\_\_, \_\_\_\_\_.

\_\_\_\_\_  
Notary Public

**COMPETITIVE BIDDER'S  
PERSONAL PROPERTY TAX AFFIDAVIT  
LOGAN COUNTY, OHIO (R.C. 5719.042)**

STATE OF OHIO:

: ss:

LOGAN COUNTY:

The undersigned, being duly sworn, says that he is or represents a competitive bidder doing business in, or with Logan County, Ohio, and that: (Check appropriate lines)

\_\_\_\_\_ He is a sole proprietorship doing business under his own name.

\_\_\_\_\_ He is a sole proprietorship doing business under the name  
of \_\_\_\_\_

\_\_\_\_\_ He is a general partner of the partnership known as  
\_\_\_\_\_

\_\_\_\_\_ He is a duly authorized officer of the corporation named  
\_\_\_\_\_

The business address of the bidder  
is \_\_\_\_\_

\_\_\_\_\_ ; Telephone \_\_\_\_\_

The undersigned further says that the bidder at the time of submitting his or its bid:

\_\_\_\_\_ Was not charged with any delinquent personal taxes in Logan County, Ohio.

\_\_\_\_\_ Was charged with delinquent personal property taxes as follows:

YEAR	AMOUNT	PENALTY	INTEREST
20_____	\$_____	\$_____	\$_____
20_____	\$_____	\$_____	\$_____
20_____	\$_____	\$_____	\$_____

Signed: \_\_\_\_\_

Title: \_\_\_\_\_

STATE OF OHIO:

: ss:

LOGAN COUNTY :

Before me, a notary, in and for said county, personally appeared

\_\_\_\_\_ (sole proprietor doing business under his own name)

(sole proprietor doing business under the name of \_\_\_\_\_)

(general partner of the Partnership known as \_\_\_\_\_)

(duly authorized officer of the Corporation name \_\_\_\_\_),

who acknowledged that he is authorized in the premises and that his signing of this instrument is the free act and deed of himself or the organization which he represents.

In testimony whereof, I have hereunto subscribed my name and affixed my official seal at

\_\_\_\_\_, Ohio, this \_\_\_\_\_ day of \_\_\_\_\_, 2\_\_\_\_\_.

\_\_\_\_\_  
Notary Public

COMMISSIONERS:

\_\_\_\_\_ No delinquent taxes – file

\_\_\_\_\_ Delinquent taxes - sent to County Engineer

\_\_\_\_\_  
Clerk

## PLAN HOLDER'S LIST

### BR. 34-4.78

Hanson Pipe & Precast  
4625 Hardin Wapak Rd.  
Sidney, OH 45365  
(937) 492-9119  
Fax (937) 492-8434

United Precast, Inc.  
Attn: Chris Melton  
P.O. Box 991 Roundhouse Lane  
Mount Vernon, OH 43050  
(800) 366-8740  
Fax (614) 392-9708

Carr Concrete  
Attn: Robert E. "Burr" Stanley, Jr.  
P.O. Box 265  
Waverly, WV 26184-0265

Builders Exchange-Dayton  
2077 Embury Park Road  
Dayton, OH 45414  
1-866-907-6300  
1-937-278-3843 (Fax)

McGraw-Hill/Dodge Reports  
950 Contract Street  
Suite 100-A  
Lexington, KY 40505  
1-859-425-6630

Ohio Construction News  
7261 Engle Road, Suite 304  
Cleveland, OH 44130

Lindsay Concrete Products Co., Inc.  
PO Box 578, 6845 Erie Ave.  
Canal Fulton, Ohio 44614  
330-854-4511  
fax 330-854-6664

Laborers-Employers Cooperation and Education Trust  
P.O. Box 46217  
Cincinnati, OH 45246  
614-832-7134 (Phone)  
614-839-9298 (Fax)  
Attn: Carmen D. Henderson  
swo-lecet@cinci.rr.com

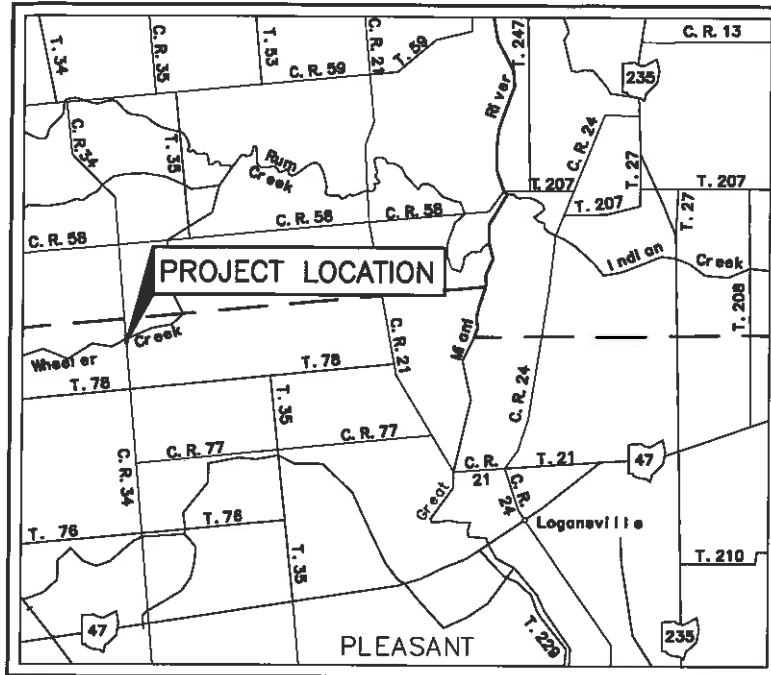

LOCATION MAP

**LOGAN COUNTY  
ENGINEER'S OFFICE**  
**SCOTT C. COLEMAN, P.E., P.S.**  
**COUNTY ENGINEER**

**BRIDGE 34-4.78  
REPLACEMENT**

**PLEASANT TOWNSHIP  
2014**

**PROJECT DESCRIPTION**

THE REPLACEMENT OF A SINGLE SPAN CONCRETE SLAB ON CONCRETE ABUTMENTS WITH A PRECAST REINFORCED CONCRETE FOUR-SIDED BOX CULVERT WITH PRECAST WINGWALLS, AND MINOR APPROACH ROADWAY WORK.

CONTRACTED WORK WILL INCLUDE THE DESIGN, MANUFACTURE AND INSTALLATION OF THE PRECAST BOX CULVERT AND WINGWALLS ONLY. ALL OTHER WORK WILL BE BY COUNTY FORCES.

PORTION TO BE IMPROVED \_\_\_\_\_  
STATE AND FEDERAL ROUTES \_\_\_\_\_  
OTHER ROADS \_\_\_\_\_

**DESIGN DESIGNATION**

CURRENT A.D.T. (2013) \_\_\_\_\_ 213  
DESIGN YEAR A.D.T. (2033) \_\_\_\_\_ 385  
DESIGN HOURLY VOLUME (2033) \_\_\_\_\_ N/A  
DIRECTIONAL DISTRIBUTION \_\_\_\_\_ 50%  
TRUCKS (24 HOUR B&C) \_\_\_\_\_ 1%  
DESIGN SPEED \_\_\_\_\_ 55 MPH  
LEGAL SPEED \_\_\_\_\_ 55 MPH  
DESIGN FUNCTIONAL CLASSIFICATION \_\_\_\_\_ LOCAL RURAL

**INDEX OF SHEETS**

TITLE SHEET \_\_\_\_\_ 1  
SITE PLAN \_\_\_\_\_ 2  
STRUCTURE DETAILS \_\_\_\_\_ 3

**2010 SPECIFICATIONS**

EXCEPT WHERE OTHERWISE NOTED, THE CONSTRUCTION AND MATERIAL SPECIFICATIONS OF THE STATE OF OHIO, DATED JANUARY 1, 2010, INCLUDING CHANGES AND SUPPLEMENTAL SPECIFICATIONS LISTED HEREON, SHALL GOVERN THIS IMPROVEMENT.

**DOMESTIC STEEL**

DOMESTIC STEEL USE REQUIREMENTS AS SPECIFIED IN SECTION 153.011 OF THE OHIO REVISED CODE APPLY TO THIS PROJECT. COPIES OF SECTION 153.011 OF THE OHIO REVISED CODE CAN BE OBTAINED FROM ANY OF THE OFFICES OF THE DEPARTMENT OF ADMINISTRATIVE SERVICES.

**APPROVALS**

WE, THE COMMISSIONERS OF LOGAN COUNTY, OHIO, HEREBY APPROVE THESE PLANS AND DECLARE THAT THE NECESSARY RIGHT-OF-WAY IS AVAILABLE FOR THIS IMPROVEMENT.

DATE \_\_\_\_\_

BOARD OF LOGAN COUNTY, OHIO,  
COMMISSIONERS

DATE \_\_\_\_\_

LOGAN COUNTY, OHIO, ENGINEER



PLANS PREPARED BY:  
LOGAN COUNTY ENGINEER'S OFFICE  
1991 C.R. 13, P.O. BOX 427  
BELLEFONTAINE, OHIO 43311

ENGINEER'S SEAL	STANDARD CONSTRUCTION DRAWINGS	SUPPLEMENTAL SPECIFICATIONS

FEDERAL PROJECT NO. NON-FEDERAL  
 PID NO. NONE  
 WORK ORDER NO. 5714  
 RAILROAD INVOLVEMENT NONE  
 BRIDGE 34-4.78  
 1/3

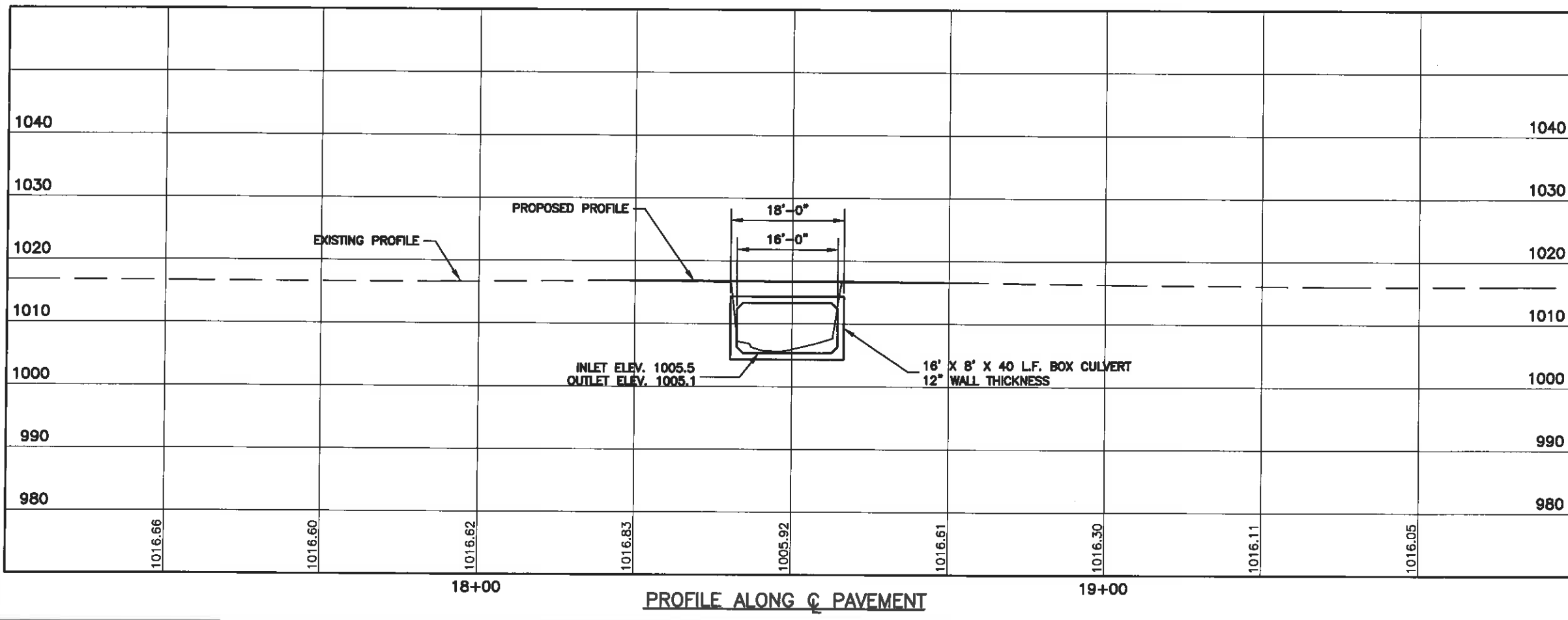
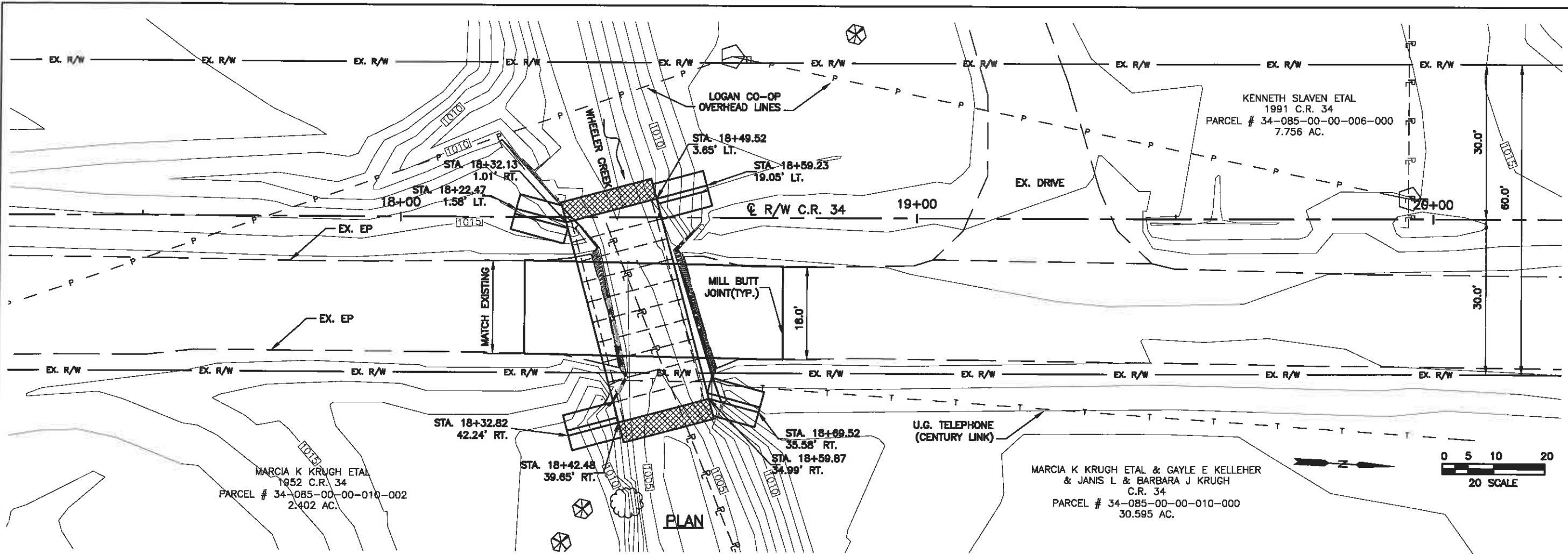

SURVEY CONTROL	
PT. #341 STONE FOUND IN MONUMENT BOX P.I. @ STA. 0+00	1040
PT. #340 STONE FOUND WITH PIECES OF BRICKS P.I. @ STA. 26+73.55	1030
PT. #339 FOUND 5/8" IRON 1.67' RT STA 28+73.69	1020
EXISTING STRUCTURE	
TYPE: SINGLE SPAN CONCRETE SLAB ON CONCRETE ABUTMENTS SPAN: 16'-0" F/F ABUTMENTS ROADWAY: 22'-4"± LOADING: UNKNOWN SKEW: 15° WEARING SURFACE: ASPHALT CONCRETE APPROACH SLAB: NONE DATE BUILT: 1991 STRUCTURAL FILE NUMBER: 4833032	
PROPOSED STRUCTURE	
TYPE: 40 L.F. PRECAST REINFORCED CONCRETE 4-SIDED BOX CULVERT WITH PRECAST CONCRETE HEADWALLS. SPAN: 16'-0" SPAN X 8'-0" RISE ROADWAY: 18'-0" LOADING: HL-93 SKEW: 15° RIGHT FORWARD WEARING SURFACE: ASPHALT CONCRETE ALIGNMENT: TANGENT SUPERELEVATION: NONE APPROACH SLAB: NONE CROWN: 0.018 LONGITUDE: 40°22'00" LATITUDE: 83°58'48"	

LOGAN COUNTY ENGINEER'S OFFICE  
1991 C.R. 13, P.O. BOX 427  
BELLEFONTAINE, OHIO 43111

DESIGNED BY: MJK  
CHECKED BY: BOD

DATE: 12/13/13  
REVIEWED BY: SCC  
STRUCTURAL FILE NUMBER: 4833040

DESIGN AGENCY: LOGAN COUNTY ENGINEER'S OFFICE  
1991 C.R. 13, P.O. BOX 427  
BELLEFONTAINE, OHIO 43111

SITE PLAN  
BRIDGE 34-4.78  
OVER WHEELER CREEK

BRIDGE 34-4.78

2/3

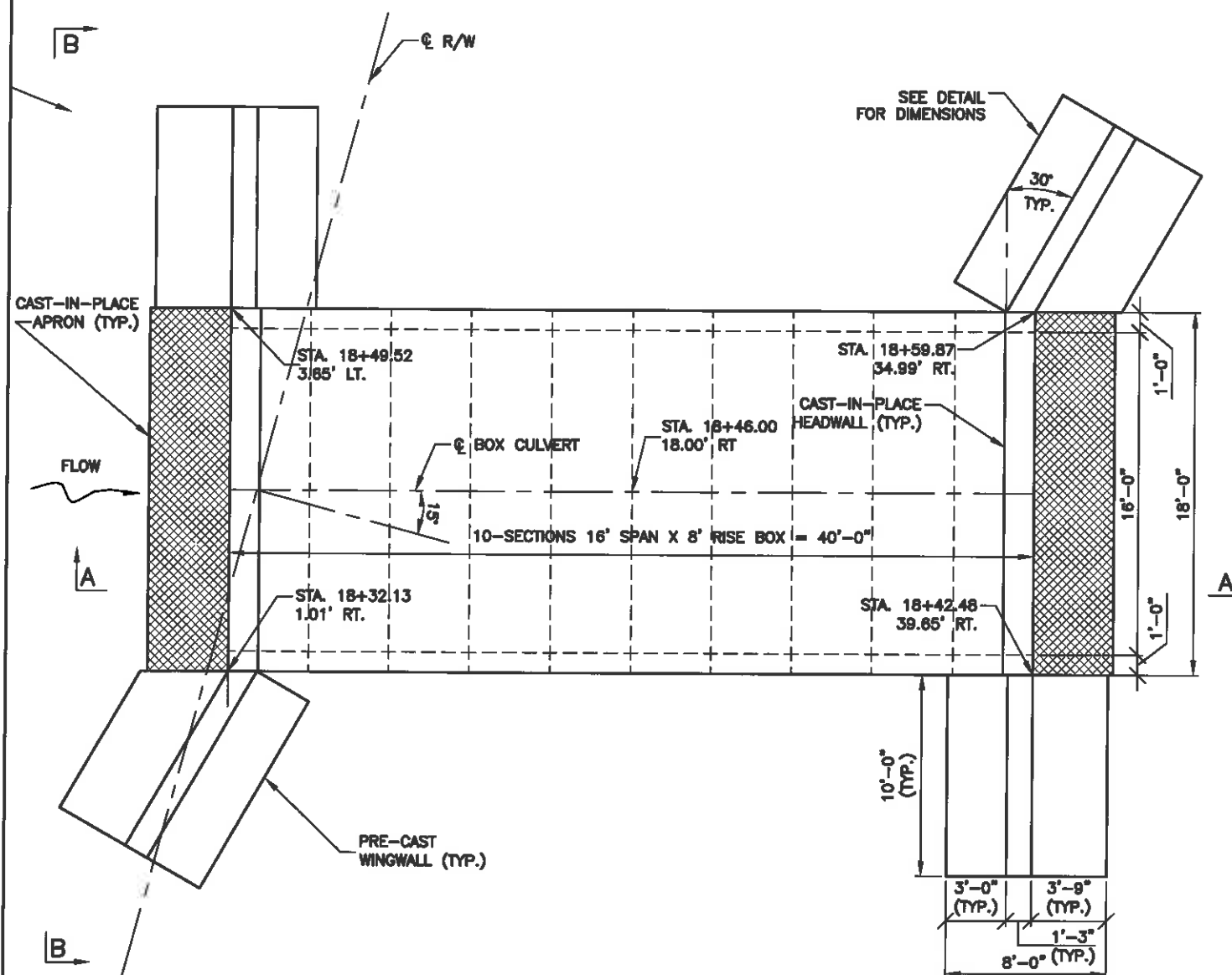

NOTE:  
ALL CONCRETE SHALL INCLUDE IPANEX  
ADMIXTURE AT A RATE OF 13.8 OZ. PER  
100 LBS. OF CEMENT.

PRE-CAST WINGWALL NOTES:  
ALL REBAR SHALL BE GRADE 60, UNCOATED BARS.  
MINIMUM 29" LAP LENGTH FOR #5 BARS.  
MINIMUM 2" CONCRETE COVER REQUIRED.  
CONCRETE SHALL BE ODOT CLASS C OR EQUAL.

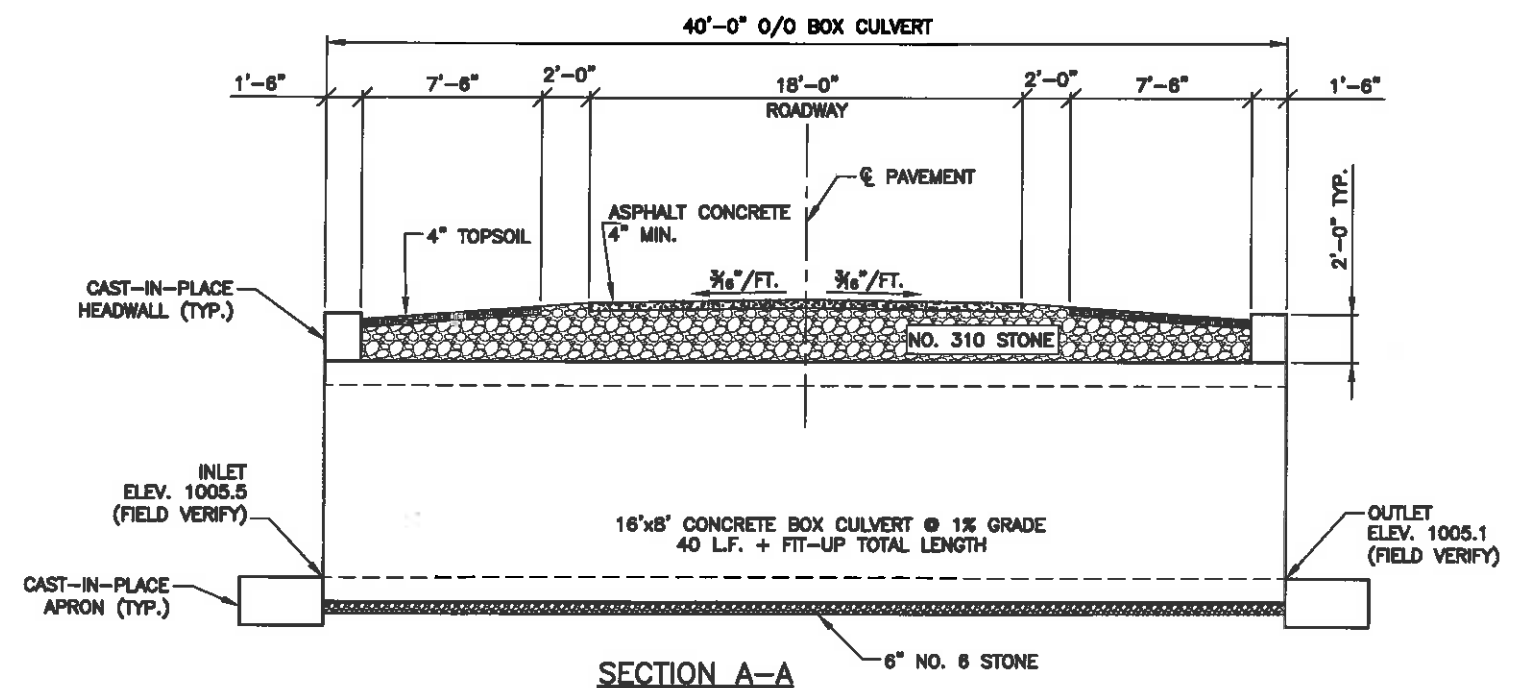
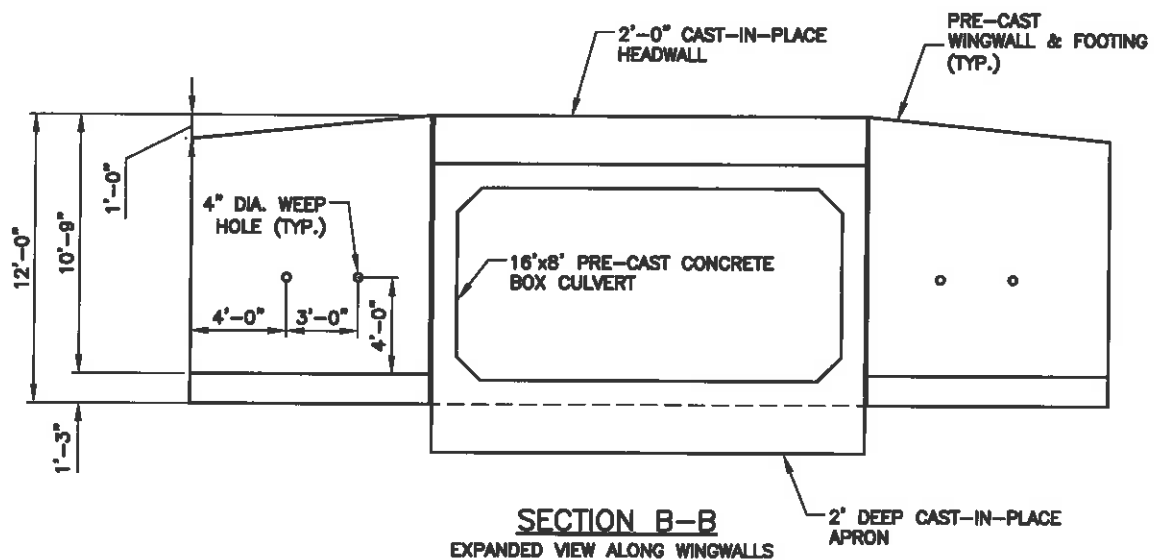
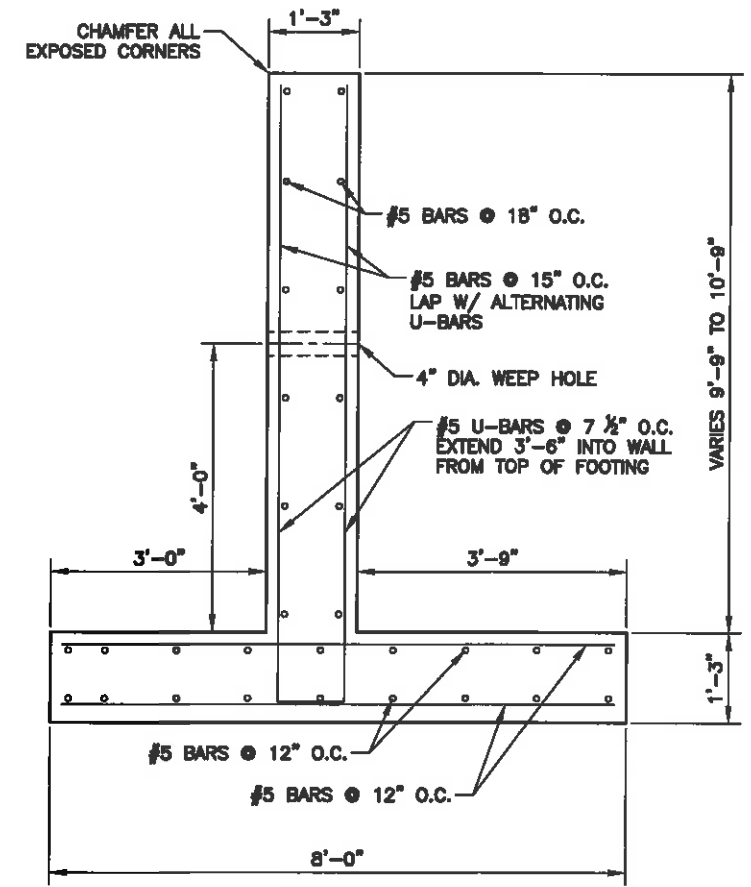
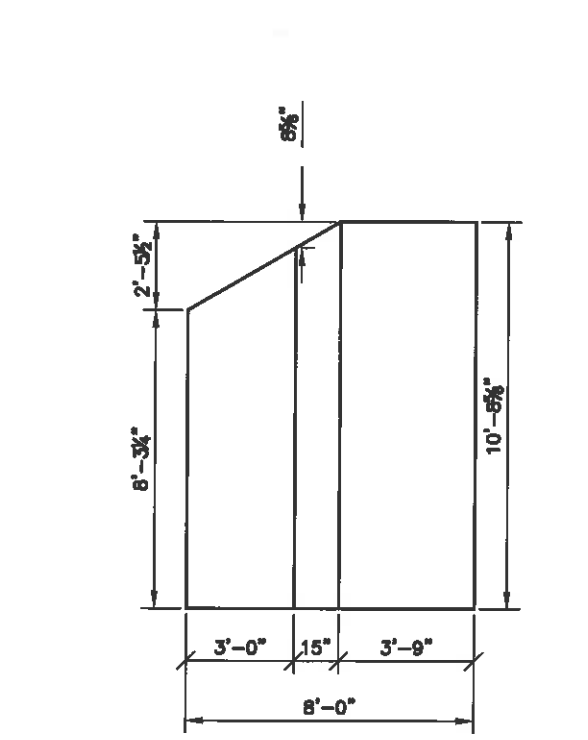

LOGAN COUNTY ENGINEER'S OFFICE  
1991 C.R. 13, P.O. BOX 427  
BELLEFONTAINE, OHIO 43311

DESIGNED BY: MJK  
CHECKED BY: BDD

DATE: 12/13/13

REVIEWED BY: SCC

STRUCTURAL FILE NUMBER: 4833040

BRIDGE 34-4.78  
OVER WHEELER CREEK

3